

INSTALLATION MANUAL

LAKEFIELD

Model: #56150



FREE-STANDING DIRECT VENT GAS FIREPLACE

English and French Installation Manuals Available Through Your Local Dealer or Visit Our Website at www.kozyheat.com

Les manuels d'installation en anglais et en français sont disponibles chez votre détaillant local ou en visitant notre site Web : www.kozyheat.com

IMPORTANT: This installation manual is to be used in conjunction with SUPPLEMENTAL INSTALLATION AND HOMEOWNER INFORMATION MANUAL. Read both manuals before installing and operating appliance.

INSTALLER: Leave this manual with the appliance.
CONSUMER: Retain this manual for future reference.

This appliance may be installed in an aftermarket permanently located, manufactured home (USA only) or mobile home, where not prohibited by local codes. This appliance is only for use with the type of gas indicated on the rating plate. This appliance is not convertible for use with other gases, unless a certified kit is used.

WARNING: If the information in these instructions is not followed exactly, a fire or explosion may result causing property damage, personal injury or loss of life.

—Do not store or use gasoline or other flammable vapors and liquids in the vicinity of this or any other appliance.

WHAT TO DO IF YOU SMELL GAS:

- ❑ Do not try to light any appliance.
- ❑ Do not touch any electrical switch: do not use any phone in your building.
- ❑ Immediately call gas supplier from a neighbors phone. Follow the gas supplier instructions.
- ❑ If you cannot reach your gas supplier, call the fire department.

— Installation and service must be performed by a qualified installer, service agency or the gas supplier.



WARNING



**HOT GLASS WILL CAUSE BURNS.
DO NOT TOUCH GLASS UNTIL COOLED.
NEVER ALLOW CHILDREN TO TOUCH GLASS.**



JULY 2012
LKF-REV-12-SEPARATE

INTRODUCTION

Read this manual before installing or operating this appliance.
Please retain this owner's manual for future reference.

CONGRATULATIONS!

We welcome you as a new owner of a Kozy Heat gas fireplace. Kozy Heat products are designed with superior components and materials and assembled by trained craftsmen who take pride in their work. The burner and valve assembly are 100% test-fired and the complete fireplace is thoroughly inspected before packaging to ensure that you receive a quality product. Our commitment to quality and customer satisfaction have remained the same for over 30 years. We offer a complete line of gas and wood fireplaces, unique cabinets and stylish accessories to compliment any décor. Adding a fireplace is one of the best ways to increase the value of your home and we are proud to offer a network of dealers throughout the country to help make your experience everything you imagine. We pride ourselves in being dedicated to not only function and reliability, but customer safety as well. We offer our continual support and guidance to help you achieve the maximum benefit and enjoyment from your Kozy Heat gas fireplace.

Jim Hussong
President



Dudley Hussong
Board Chairman



Homeowner Reference Information

We recommend that you record the following information about your fireplace.

Model Name: _____ Date purchased/installed: _____

Serial Number: _____ Location on fireplace: _____

Dealership purchased from: _____ Dealer Phone: _____

Notes: _____

TABLE OF CONTENTS

<u>INTRODUCTION</u>	
Introduction and Homeowner Reference Information	1
<u>CONTENTS</u>	
Table of Contents	2
<u>SAFETY INFORMATION</u>	
Safety Information	3
<u>COMMONWEALTH OF MASSACHUSETTS INFORMATION</u>	
Commonwealth of Massachusetts Information	4
<u>SPECIFICATIONS</u>	
Fireplace Dimensions	5
Clearances	5
Installation Overview	6
Placement Clearance Requirements	6
<u>FRAMING</u>	
Vertical Terminations	7
Horizontal Terminations	7
<u>GLASS FRAME ASSEMBLY</u>	
Glass Frame Assembly	7
<u>GAS LINE CONNECTION</u>	
Gas Line Connection	8
<u>VENTING</u>	
Approved Venting	9
Horizontal Terminations	9
Vertical Terminations	9
Horizontal / Vertical Combination Terminations	10
Restrictor Requirements / Installation	10
Elbows	10
Termination Cap Location	11
Vent Termination Clearances (Vertical Cap Requirements)	12

<u>LOG SET INSTALLATION</u>	
Log Set Installation	13
<u>MILLIVOLT BOARD REMOVAL / INSTALLATION</u>	
Millivolt Board Removal / Installation	14
<u>FINALIZING THE INSTALLATION</u>	
Flame Appearance	15
To Adjust Venturi	15
Restrictor Troubleshooting / Installation After Termination Completion	16
Seasonal Heat Dump	17
<u>MAINTENANCE</u>	
Maintenance	18
<u>WARRANTY</u>	
Warranty	19-20

SAFETY INFORMATION

This fireplace has been tested by PFS Corporation, Madison, Wisconsin and complies with:

ANSI Z21.88-2009/CSA 2.33-2009, "Standard for Vented Gas Fireplace Heaters."

CAN 2.14-M91, "Gas-Fired for Use at High Altitudes."

CAN/CSA P.4.1-02, "Testing Method for Measuring Annual Efficiency".

This installation must conform with local codes, or in the absence of local codes, with the *National Fuel Gas Code, ANSI Z223.1/NFPA 54*, or the *Natural Gas and Propane Installation Code, CSA B149.1*

- Installation and repair should be done only by a qualified service person. The appliance should be inspected by a qualified service person before use. Annual inspection by a qualified service person is required to maintain warranty. More frequent cleaning may be required due to excessive lint from carpeting, bedding materials, etc. It is imperative that control compartments, burners and circulation air passageways of the appliance be kept clean.
- If this appliance is installed directly on carpeting, tile or other combustible material other than wood flooring, the appliance shall be installed on a metal or wood panel extending the full width and depth of the appliance.
- Children and adults should be alerted to the hazards of high surface temperatures and should stay away to avoid burns or clothing ignition.
- Young children should be carefully supervised when they are in the same room as the appliance. Toddlers, young children and others may be susceptible to accidental contact burns. A physical barrier is recommended if there are at risk individuals in the house. To restrict access to a fireplace or stove, install an adjustable safety gate to keep toddlers, young children and other at risk individuals out of the room and away from hot surfaces.
- Clothing or other flammable material should not be placed on or near the appliance.
- Adequate accessibility clearances for servicing and proper operation must be maintained.
- This appliance must not share or be connected to a chimney flue serving any other appliance.
- Keep area around the appliance clear of combustible materials, gasoline and other flammable vapor and liquids.
- The flow of combustion and ventilation air must not be obstructed.
- Due to high temperatures the appliance should be located out of traffic and away from furniture and draperies.
- The glass front or any part removed for servicing the appliance must be replaced prior to operating the appliance. Work should be done by a qualified service technician.
- Clean glass only when cool and only with non-abrasive cleansers.
- **WARNING: DO NOT OPERATE APPLIANCE WITH THE GLASS/FRAME ASSEMBLY REMOVED, CRACKED OR BROKEN. REPLACEMENT OF THE GLASS SHOULD ONLY BE PERFORMED BY A LICENSED OR QUALIFIED SERVICE PERSON.**
- The glass assembly, Part #700-015T, shall only be replaced as a complete unit, as supplied by Hussong Mfg. Co., Inc. DO NOT SUBSTITUTE MATERIALS.
- Do not strike or slam glass assembly.
- Any safety screen or guard removed for servicing the appliance must be replaced prior to operating the appliance.
- Under no circumstances should any solid fuel (wood, coal, paper or cardboard etc.) be used in this appliance.
- Keep burner and control compartment clean.
- Do not use this fireplace if any part has been under water. Immediately call a qualified service technician to inspect this appliance and to replace any part of the control system and any gas control which has been under water.

COMMONWEALTH OF MASSACHUSETTS REQUIREMENTS

NOTE

The following requirements reference various Massachusetts and national codes not contained in this manual.

For all sidewall horizontally vented gas fueled equipment installed in every dwelling, building or structure used in whole or in part for residential purposes, including those owned or operated by the Commonwealth and where the side wall exhaust vent termination is less than (7) feet above finished grade in the area of the venting, including but not limited to decks and porches, the following requirements shall be satisfied:

INSTALLATION OF CARBON MONOXIDE DETECTORS

At time of installation of side wall horizontally vented gas fueled equipment, the installing plumber or gas-fitter shall observe that a hard wired carbon monoxide detector with an alarm and battery back-up is installed on the floor level where the gas equipment is to be installed. In addition, the installing plumber or gas-fitter shall observe that a battery operated or hard wired carbon monoxide detector is installed on each additional level of the dwelling, building or structure served by the side wall horizontal vented gas fueled equipment. It shall be the responsibility of the property owner to secure the services of qualified licensed professionals for the installation of hard wired carbon monoxide detectors.

In the event that the side wall horizontally vented gas fueled equipment is installed in a crawl space or attic, the hard wired carbon monoxide detector with alarm and battery back-up may be installed on the next adjacent floor level.

In the event that the requirements of this subdivision can not be met at the time of completion of installation, the owner shall have a period of thirty (30) days to comply with the above requirements; provided, however, that during said thirty (30) day period, a battery operated carbon monoxide detector with an alarm shall be installed.

APPROVED CARBON MONOXIDE DETECTORS

Each carbon monoxide detector as required in accordance with the above provisions shall comply with NFPA 720 and be ANSI/UL 2034 listed and IAS certified.

SIGNAGE

A metal or plastic identification plate shall be permanently mounted to the exterior of the building at a minimum of eight (8) feet above grade directly in line with the exhaust vent terminal for the horizontally vented gas fueled heating appliance or equipment. The sign shall read, in print no less the one-half inch (1/2) in size, **“GAS VENT DIRECTLY BELOW. KEEP CLEAR OF ALL OBSTRUCTIONS”**.

INSPECTION

The state or local gas inspector of the side wall horizontally vented gas fueled equipment shall not approve the installation unless, upon inspection, the inspector observes carbon monoxide detectors and signage installed in accordance with the provisions of 248 CMR 5.08 (2) (a) 1 through 4.

EXEMPTIONS

The following equipment is exempt from 248 CMR 5.08 (2) (a) 1 through 4: The equipment listed in Chapter 10 entitled “Equipment Not Required To Be Vented” in the most current edition of NFPA 54 as adopted by the Board; and Product Approved side wall horizontally vented gas fueled equipment installed in a room or structure separate from the dwelling, building or structure used in whole or in part for residential purposes.

MANUFACTURER REQUIREMENTS - GAS EQUIPMENT VENTING SYSTEM PROVIDED

When the manufacturer of Product Approved side wall horizontally vented gas equipment provides a venting system design or venting system components with the equipment, the instructions provided by the manufacturer for installation of the equipment and the venting system shall include:

Detailed instructions for the installation of the venting system design or the venting system components; and

A complete parts list for the venting system design or venting system.

MANUFACTURER REQUIREMENTS - GAS EQUIPMENT VENTING SYSTEM NOT PROVIDED

When the manufacturer of Product Approved side wall horizontally vented gas equipment does not provide the parts for venting the flue gases, but identifies “special venting systems”, the following requirements shall be satisfied by the manufacturer:

The referenced “special venting systems” instructions shall be included with the appliance or equipment installation instructions and;

The “special venting systems” shall be Product Approved by the Board, and the instructions for that system shall include a parts list and detailed installation instructions.

A copy of all installation instructions for all Product Approved side wall horizontally vented gas fueled equipment, all venting instructions, all parts lists for venting instructions, and/or all venting design instructions shall remain with the appliance or equipment at the completion of the installation.

SPECIFICATIONS

DIMENSIONS

DESCRIPTION	Height	Width	Depth (at leg base)	Depth (at unit top)	Vent to unit back	Unit top to vent top
INCHES	27-3/4	27-1/2	17-1/4	16-1/2	4	2-1/2
MILLIMETERS	705	699	438	419	102	64

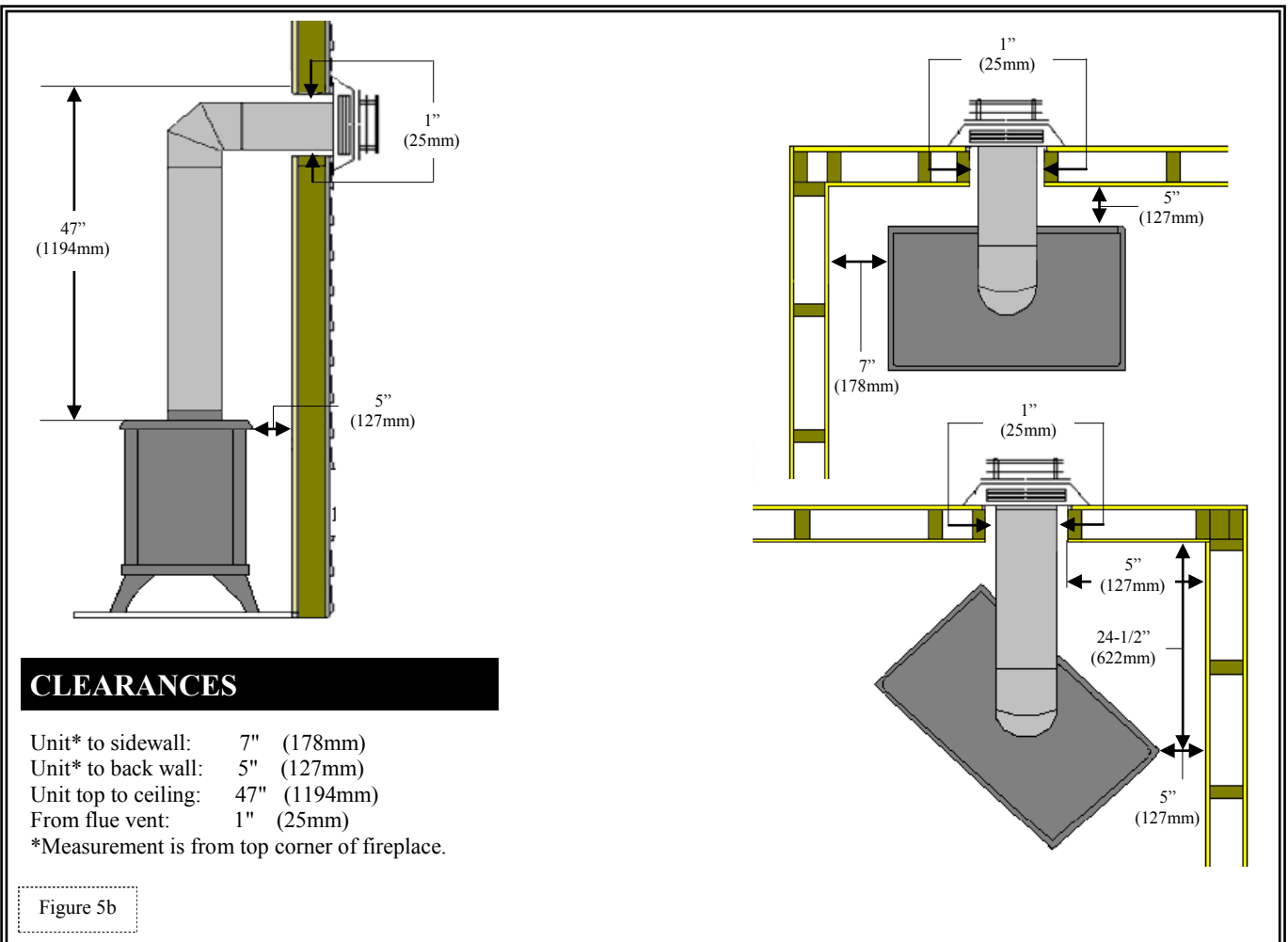
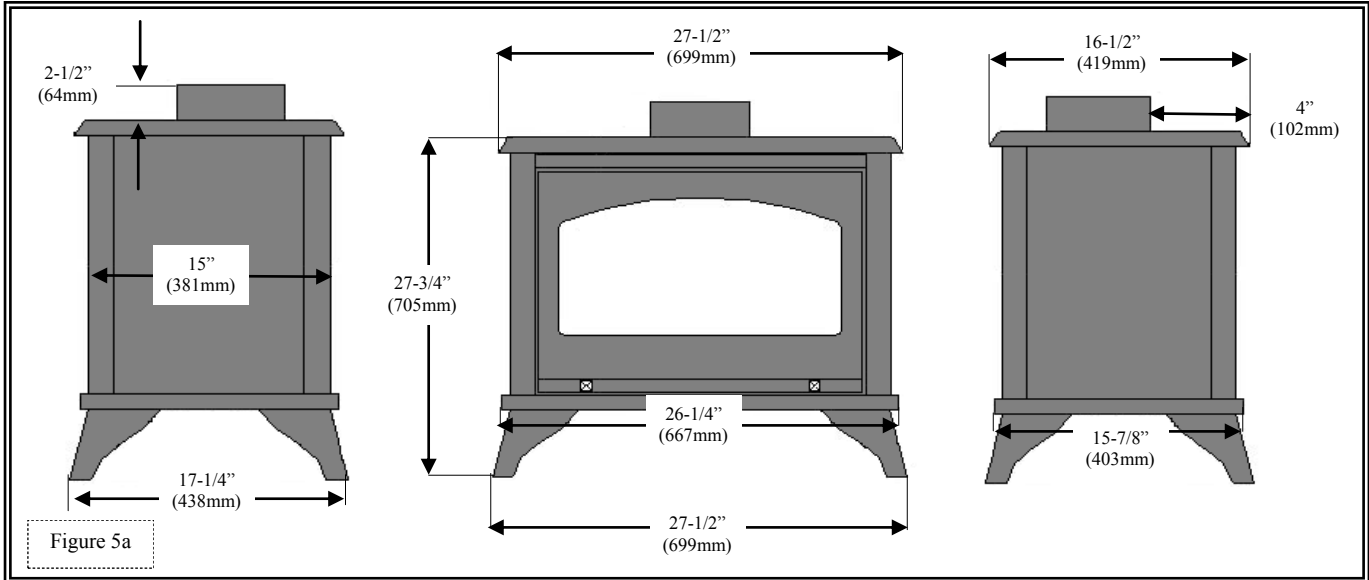

SPECIFICATIONS

INSTALLATION OVERVIEW

NOTE

The qualified installer should follow the procedure best suited for the installation.

1. Determine stove location, allowing for vent installation.
2. Install hearth (if applicable).
3. Complete gas line installation.
4. Complete electrical hook-up. Install any standard or optional electrical components at this time.
5. Complete venting installation.
6. Secure fireplace to flooring through holes located in unit legs. Verify all clearances at this point.
7. Install logs.
8. Install optional decorative doors or other accessories.
9. Verify proper operation of fireplace and all components.

PLACEMENT CLEARANCE REQUIREMENTS

- This fireplace must be installed on a level surface capable of supporting fireplace and venting.
- Fireplace must be placed directly on wood or non-combustible surface (not linoleum or carpet) extending entire depth and width of fireplace.
- Due to high surface temperatures, fireplace should be located out of traffic and away from furniture and draperies.
- This fireplace may be installed in a bedroom.
- Please be aware of the large amount of heat this fireplace will produce when determining a location.

NOTE

Other clearances apply. All clearances must be maintained.

FRAMING

IMPORTANT

Vent cap location must be in compliance with guidelines on page 11 of this manual.

Minimum venting: 75" (1.905m) from floor or hearth to top of vent pipe.

Wall pass-thru required for all horizontal runs. Refer to vent manufacturer's to determine which pass-thru will work best for your application.

HORIZONTAL TERMINATIONS

Follow vent pipe manufacturer's installation instructions for horizontal terminations. Include required 1-1/2" (38mm) top clearance (at wall pass-thru) and 1" (25mm) sides and bottom clearances for approved rigid vent systems.

VERTICAL TERMINATIONS

Follow vent pipe manufacturer's installation instructions for vertical terminations. A minimum 1" (25mm) clearance on all sides of vertical vent pipe must be maintained.

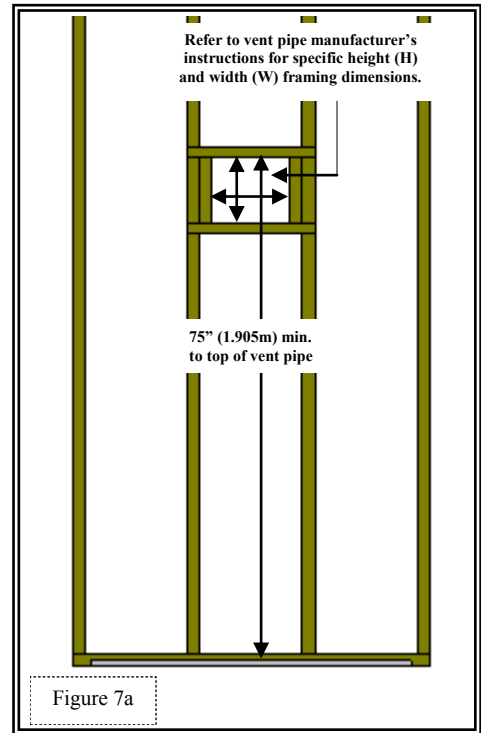

GLASS FRAME ASSEMBLY

WARNING

DO NOT OPERATE THIS FIREPLACE WITH THE GLASS REMOVED, CRACKED OR BROKEN. REPLACEMENT OF GLASS ASSEMBLY, #700-015T SHOULD BE DONE BY A LICENSED OR QUALIFIED SERVICE PERSON.

REMOVE GLASS FRAME ASSEMBLY

- Locate metal bar (glass latching mechanism) below glass frame.
- To release glass assembly, pull latch mechanism knobs out, then immediately down, securing metal bar onto stops.
- Pull bottom of glass assembly out, lifting up and off tabs at top of firebox.

INSTALL GLASS FRAME ASSEMBLY

- Place glass frame assembly top over tabs at top of firebox.
- Pull bottom handles out and up to secure glass frame assembly bottom.

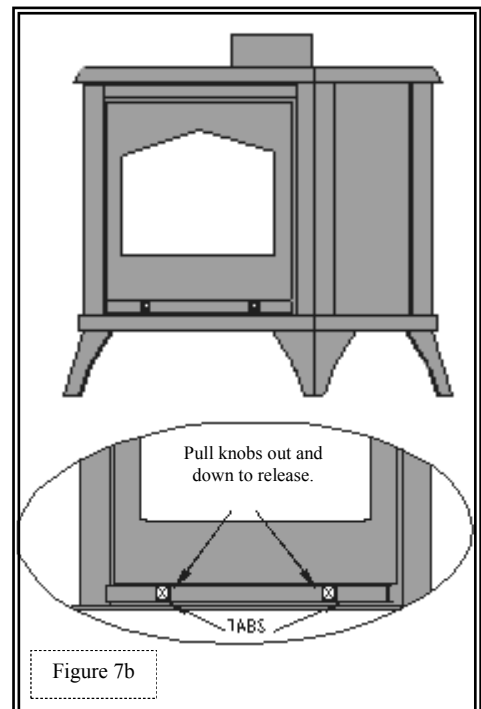

GAS LINE CONNECTION

GAS CONVERSION

This fireplace is manufactured for use with Natural Gas. Follow instructions included with conversion kit if converting to LP gas. (Sold separately).

ATTENTION	The conversion shall be carried out in accordance with the requirements of the provincial authorities having jurisdiction and in accordance with the requirements of the ANSI Z223.1 installation code.
CAUTION	<p>Installation of the gas line must only be done by a qualified person in accordance with local building codes, if any. If not, follow ANSI 223.1.</p> <p>Commonwealth of Massachusetts: Installation must be done by a licensed plumber of gas fitter.</p>
NOTE	<p>A listed (and Commonwealth of Massachusetts approved) 1/2" (13mm) T-handle manual shut-off valve and flexible gas connector (included) are connected to the 1/2" (13mm) control valve inlet. If substituting for these components, please consult local codes for compliance.</p> <p>This fireplace is equipped with a 3/8"(10mm) x 18" (457mm) long flexible gas connector and manual shut-off valve. The gas line should be run to the point of connection where the shut-off valve and flexible gas line will connect.</p> <p>The appliance and its individual shutoff valve must be disconnected from the gas supply piping system during any pressure testing of that system at pressures in excess of ½ psi (3.5 kPa).</p> <p>The appliance must be isolated from the gas supply piping system by closing its individual manual shut-off valve during any pressure testing of the gas line at test pressures equal to or less than ½ psi (3.5 kPa).</p> <p>For high altitude installations, consult the local gas distributor or the authority having jurisdiction for proper rating methods.</p>
IMPORTANT	The efficiency rating of this appliance is a product of thermal efficiency rating determined under continuous operating conditions and was determined independently of any installed system.

	<u>NATURAL GAS</u>	<u>LP GAS</u>
MINIMUM INLET GAS PRESSURE	5" W.C. (1.25 kPa) (7" W.C. (1.74 kPa) recommended)	11" W.C. (2.74 kPa) (recommended)
MAXIMUM INLET GAS PRESSURE	10.5" W.C. (2.62 kPa)	13" W.C. (3.24 kPa)

VENTING

IMPORTANT

Consult local and national installation codes to assure adequate combustion and ventilation air is available.
 Flame height and appearance will vary depending upon venting configuration and type of fuel used.
 This fireplace is manufactured with appropriate adaptor for proper connection to chosen approved venting.

NOTE

Page 10 has information on restrictor installation in conjunction with venting installation. Page 16 has information on restrictor recommendations depending on burner flame appearance and instructions on installation after venting is completed.

CAUTION

This gas appliance must not be connected to or joined with any other chimney flue serving another appliance.

Refer to vent system manufacturer's installation manual for complete installation instructions.
 Installation must conform with venting requirements and restrictions as outlined in this manual.

APPROVED VENTING

- Simpson Dura-Vent DV-GS 4" x 6-5/8" direct vent system (horizontal and vertical terminations).
 - Selkirk Metalbestos Chimney System 4" x 6-5/8" (horizontal and vertical terminations).
 - Security Chimney System 4" x 6-5/8" (horizontal and vertical terminations).
 - ICC Chimney System: 4" x 6-5/8" (horizontal and vertical terminations).
 - RLH Chimney System: 4" x 6-5/8" (horizontal and vertical terminations).
 - Amerivent / American metal Chimney System: 4" x 6-5/8" (horizontal and vertical terminations).
 - Metal Fab Chimney System: 4" x 6-5/8" (horizontal and vertical terminations).
- This fireplace is designed to be used with rigid pipe only.

HORIZONTAL TERMINATIONS

HORIZONTAL VENT SYSTEM CLEARANCES

	ALL SIDES
ALL APPROVED HORIZONTAL PIPE	1 inch (25mm)

NOTE

Horizontal sections require 1/4" (6mm) rise for every 12" (305mm) of travel.

MINIMUM:

3ft. (914mm) vertical + 90-degree elbow + 6in. (152mm) horizontal + termination cap.

MAXIMUM:

3ft. (914mm) vertical + 90-degree elbow + 21ft. (6.40m) horizontal + termination cap.

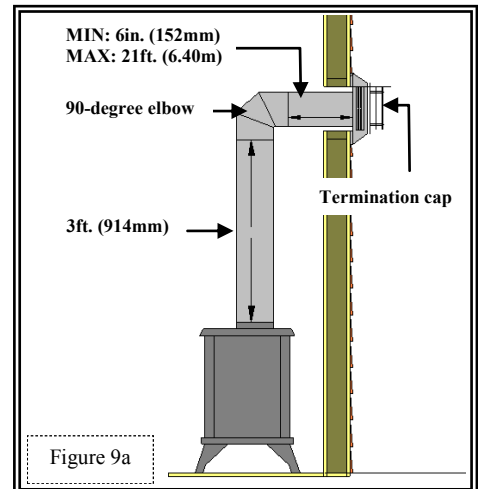

VERTICAL TERMINATIONS

VERTICAL VENT SYSTEM CLEARANCES

	ALL SIDES
ALL APPROVED VERTICAL PIPE	1 inch (25mm)

MINIMUM: 3ft. (914mm) horizontal + termination cap.

MAXIMUM: 40ft. (12.19m) horizontal + termination cap.

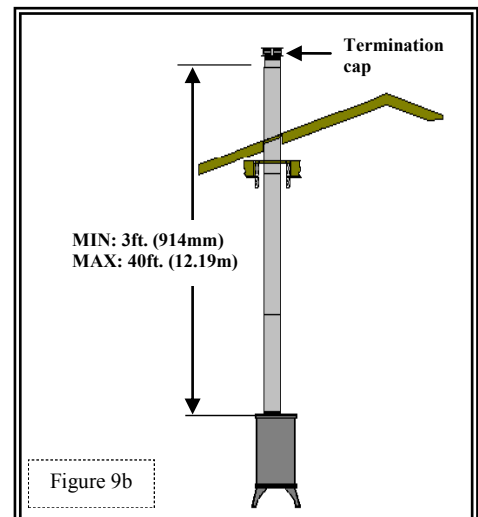

VENTING

HOR. / VERT. COMBINATION

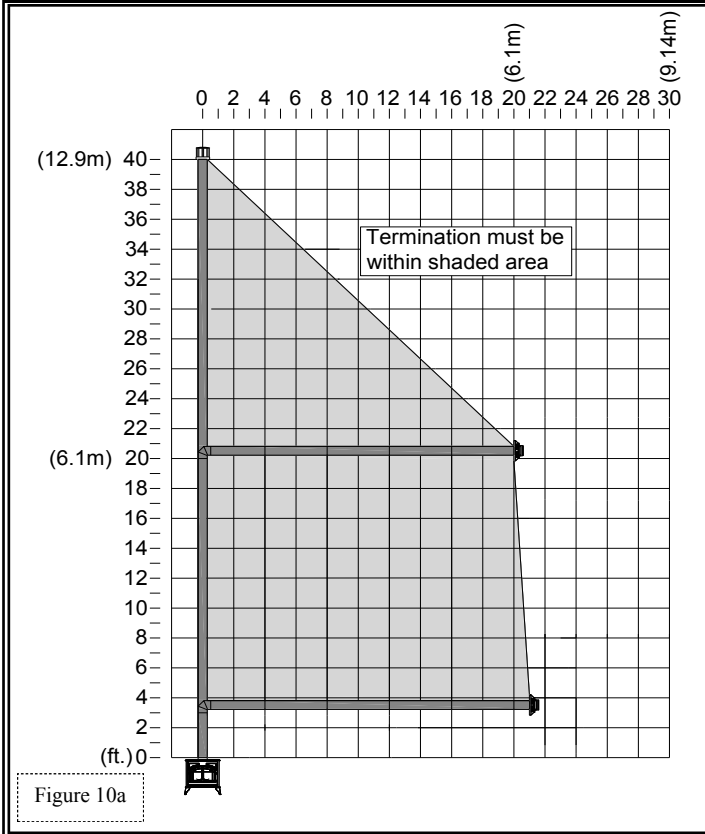

RESTRICTOR

Each installation is unique and affected by various factors including venting configuration, altitude and climate. Therefore, after fireplace installation is complete a restrictor may be required or may need to be removed or modified.

Page 16 has information on restrictor recommendations depending on burner flame appearance and instructions on installation after venting is completed.

RESTRICTOR REQUIREMENTS

Small restrictor: Straight vertical vent runs between 10' - 15' (3.048m - 4.572m).

Large restrictor: Straight vertical vent runs between 15' - 40' (4.572m - 12.19m).

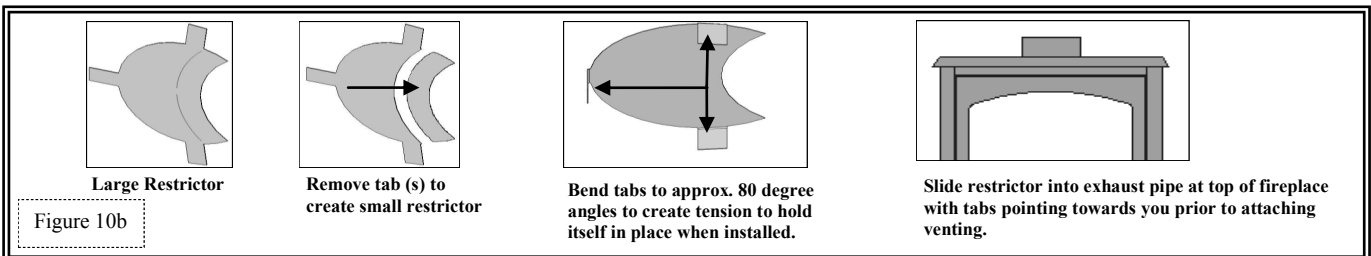

ELBOWS

For each additional 90° elbow used after first elbow, 3ft. (914mm) must be subtracted from maximum allowed venting. For each 45° elbow used, 1-1/2ft. (457mm) must be subtracted from maximum venting allowed.

NOTE

(2) 45° elbows may be used in place of (1) 90° elbow.

TERMINATION VENT CAP LOCATION

This gas appliance must not be connected to a chimney serving any other appliance.

1. Terminations against vinyl siding must use a vinyl siding protector. Follow instructions included.
2. **DO NOT RECESS TERMINATION KIT INTO OUTSIDE BUILDING MATERIALS** - i.e.: brick, stone, siding, etc. If necessary, extend framing so that termination kit will be exposed once building materials are installed.
3. Vent termination must not be located where it will become plugged by snow or other material. The flow of combustion and ventilation air must be not obstructed.

LOCATION CLEARANCES

- A. Above grade, veranda, porch, deck, balcony - 12" (305mm).
- B. Operable window or door - CANADA: 12" (305mm). US: 9" (229mm).
- C. Permanently closed window* - 12" (305mm) (recommended to prevent condensation on window).
- D. Ventilated soffit* - 24" (610mm).
- E. Unventilated soffit* - 12" (305mm).
- F. Outside corner* - 12" (305mm).
- G. Inside corner* - 12" (305mm).
- H. Meter / Regulator: CANADA: Not to be installed above a gas meter/regulator assembly within 3ft. (914mm) horizontally from the centerline of the regulator within a height of 15ft. (4.57m). US*.
- I. Gas Service regulator vent outlet : CANADA: 3ft. (914mm). US*.
- J. Non-mechanical air supply inlet to building or the combustion air inlet to any other appliance. CANADA: 12" (305mm). US: 9" (229mm).
- K. Mechanical air supply inlet. CANADA: 6ft. (1.83m) US: 3ft. (914mm) above if within 10ft. (3.05m) horizontally. Massachusetts installations: 10ft. (3.05m).
- L. Above paved side-walk or paved driveway located on public property - 7ft. (2.13m). US*.

NOTE

A vent cannot be located directly above a side-walk or paved driveway that is located between two single family dwellings and serves both dwellings.

- M. Under veranda, porch, deck, or balcony (must be fully opened on a minimum of 2 sides)** - 12" (305mm).
- N. Between two horizontal terminations - 12" (305mm).
- O. Between two vertical terminations - 12" (305mm). Terminations may be same height.
- P. Above furnace exhaust or inlet - 12" (305mm).

*Clearance must be in accordance with local installation codes & the requirements of the gas supplier.

**VINYL SOFFIT / VINYL CEILING / VINYL OVERHANG DISCLAIMER

Clearances to heat resistant material (i.e. wood, metal). This does not include vinyl. Hussong Manufacturing Co., Inc. will not be held responsible for heat damage caused from terminating under vinyl overhangs, vinyl ceilings or vinyl ventilated/unventilated soffits.

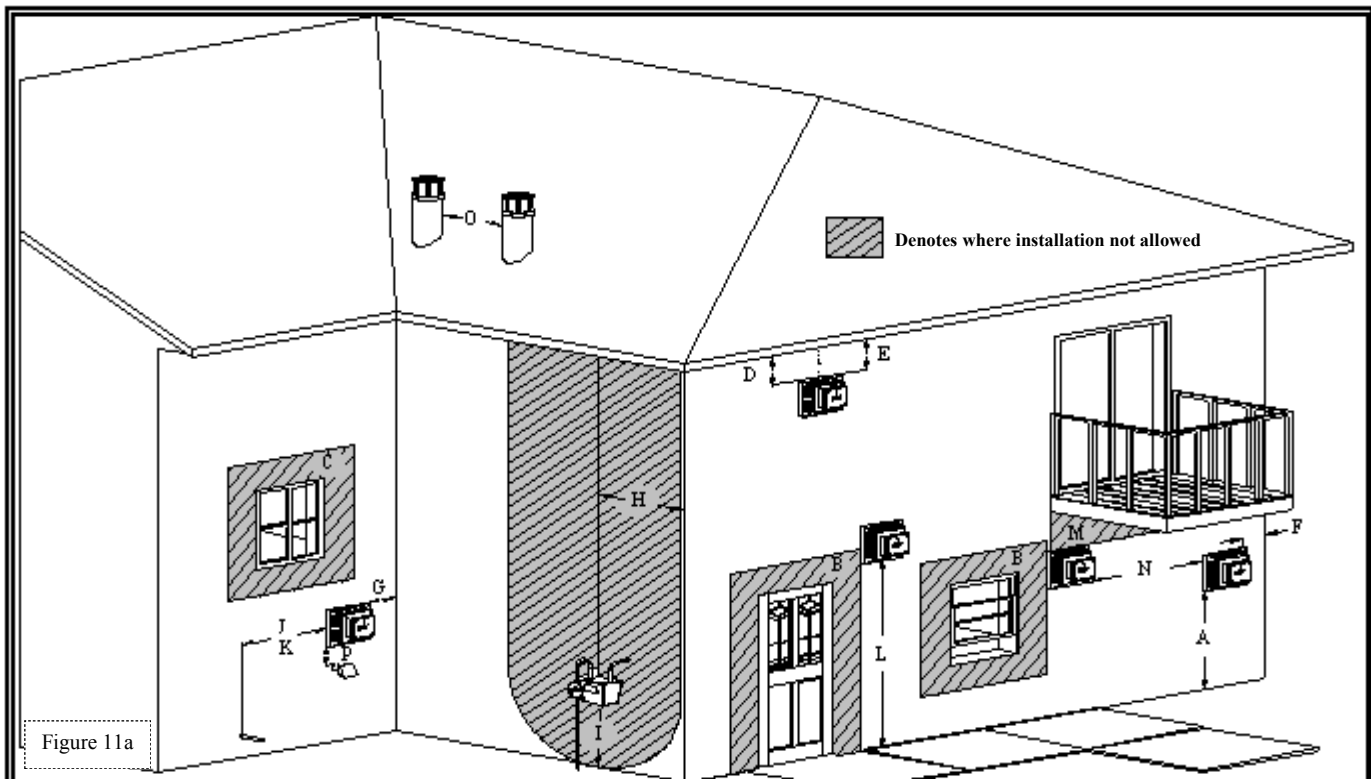

VENTING (Vertical Cap Requirements)

VENT TERMINATION CLEARANCES

Roof Pitch	H (Min.) Ft.	H (Min.) m
Flat to 6/12	1.0	0.30
Over 6/12 to 7/12	1.25	0.38
Over 7/12 to 8/12	1.5	0.46
Over 8/12 to 9/12	2.0	0.61
Over 9/12 to 10/12	2.5	0.76
Over 10/12 to 11/12	3.25	0.99
Over 11/12 to 12/12	4.0	1.22
Over 12/12 to 14/12	5.0	1.52
Over 14/12 to 16/12	6.0	1.83
Over 16/12 to 18/12	7.0	2.13
Over 18/12 to 20/12	7.5	2.27
Over 20/12 to 21/12	8.0	2.44

CAUTION

This appliance must not be connected to or joined with any chimney flue serving any other appliance.

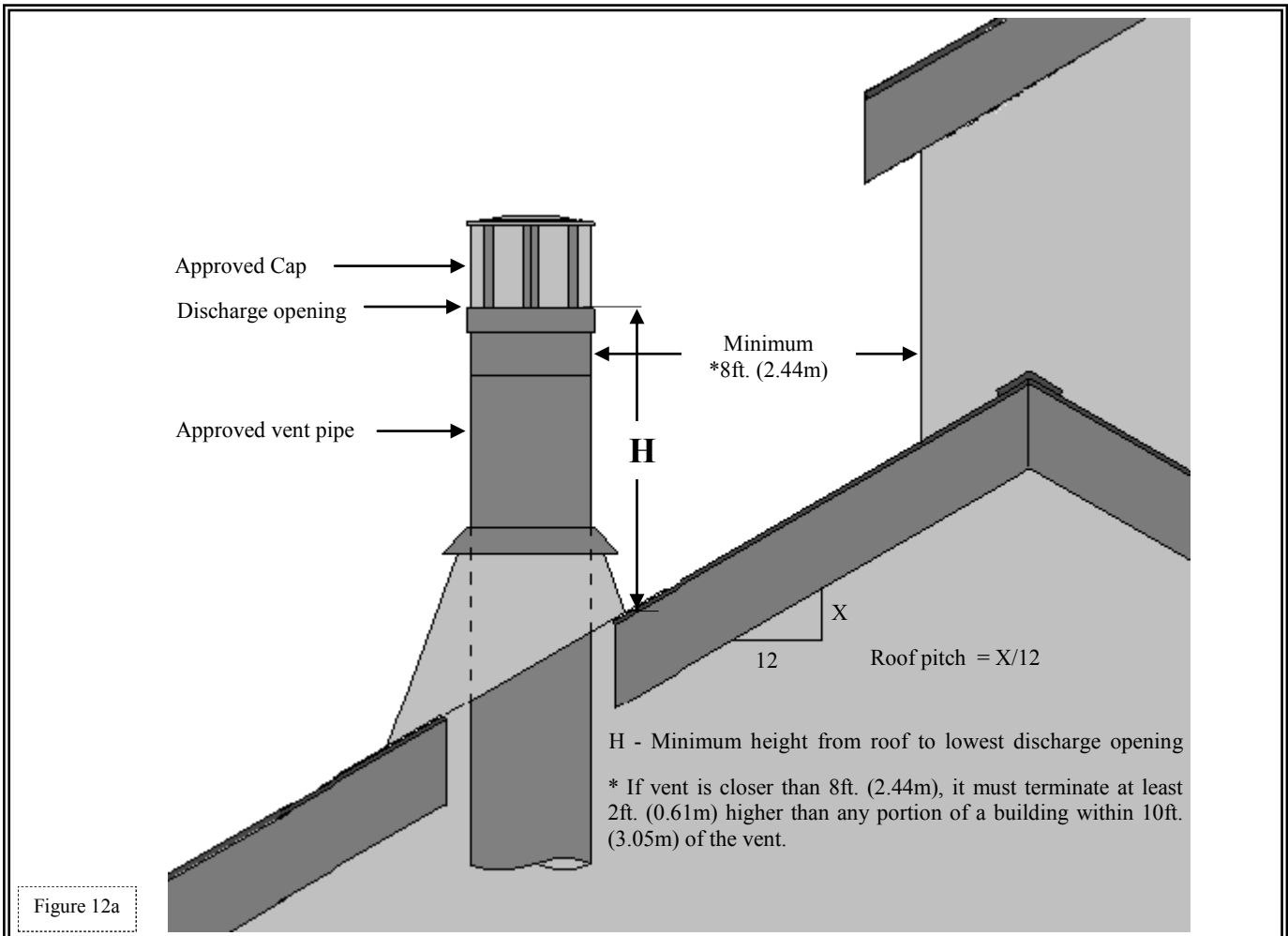

#BRK-500 LOG SET INSTALLATION

ATTENTION

If converting to LP (propane) gas, do so now before installing log set. Follow instructions included with conversion kit. (Sold separately).

NOTE

Log numbers are located on bottom of each log. Refer to following instructions and illustrations for proper placement.

CAUTION

Do not place logs directly over burner port holes. Improper log placement may affect flame appearance and cause excessive soot to build up on logs and glass.

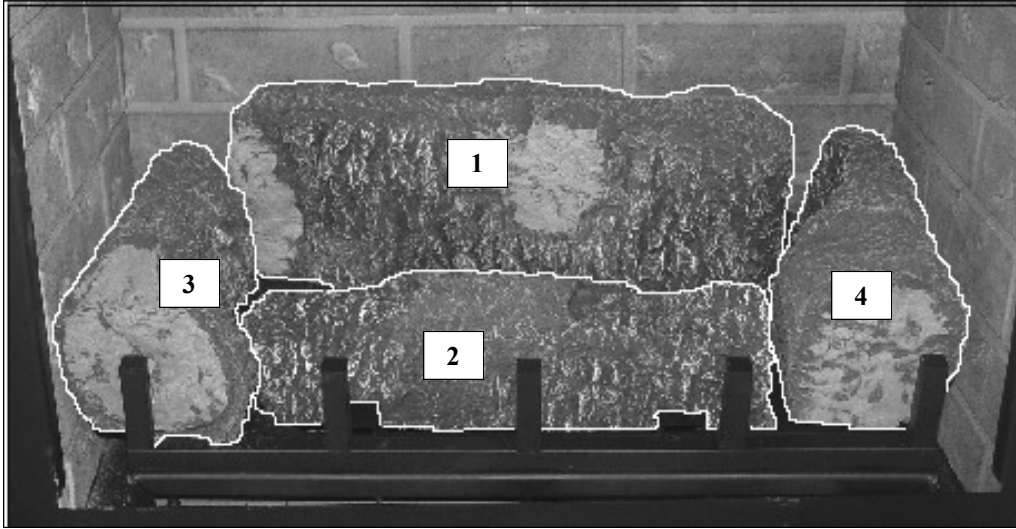

Position log #2, aligning notches in bottom of log to brackets in burner cover.
Position base logs #1, #3 & #4, aligning mounting holes in bottom of logs to corresponding mounting studs on burner cover.

Figure 13a

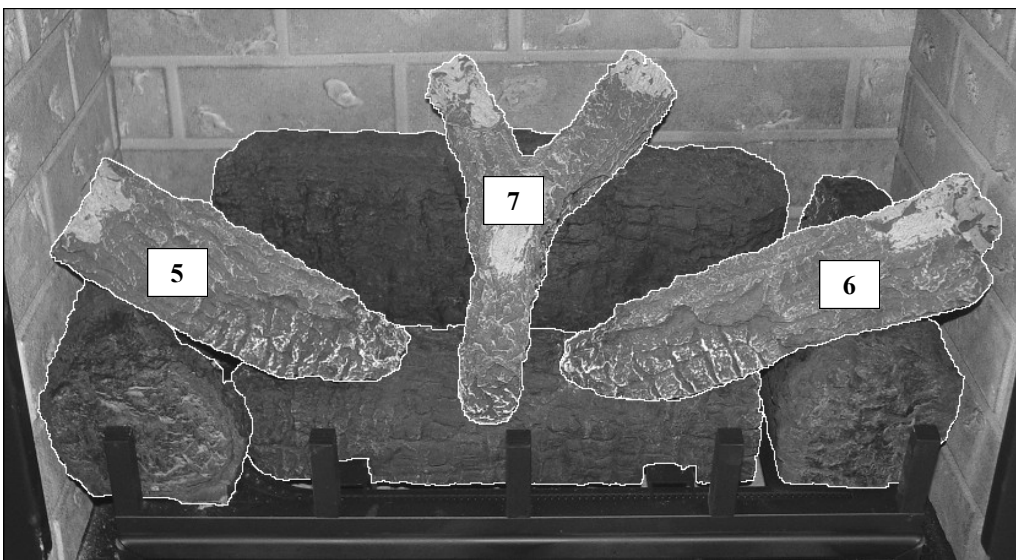

Place logs #5, #6, & #7 over base logs, nesting them into corresponding notched out sections in base logs.

Use a steel or stiff bristle nylon brush to distribute Rock Wool Embers onto logs and burner.

Figure 13b

MILLIVOLT BOARD REMOVAL & INSTALLATION

REMOVAL

CAUTION

If burner and/or pilot have been burning, use appropriate protection to avoid burns or damage to personal property before removing any components.

1. Turn valve control knob to OFF position.
2. Shut off gas supply at manual shut off valve.
3. Disconnect flexible gas line from manual shut off valve.
4. Disconnect on/off rocker switch wires from top & bottom terminals on valve.
5. Disconnect any remote control, wall switch or thermostat wires from gas valve.
6. Remove glass assembly. Page 7.
7. Remove log set and set aside where they will not be broken.
8. Remove burner cover by lifting front of cover up and to the right.
9. Remove (7) nuts securing board. Lift board up and out of firebox.

INSTALLATION

WARNING

DO NOT OPERATE FIREPLACE WITHOUT SEALING GASKET (LOCATED UNDER MILLIVOLT BOARD) IN PLACE. IF GASKETING IS DAMAGED, IT MUST BE REPLACED.

1. Place board in firebox, aligning holes in control board to mounting studs. MAKE SURE SEALING GASKET IS IN PLACE ON FIREBOX BOTTOM! Secure with nuts previously removed.
2. Reinstall burner cover, making sure burner tube is properly positioned over burner orifice and sides of cover are inside flanges on board.
3. Re-connect flexible gas line to manual shut off valve.
4. Reconnect any remote control, wall switch or thermostat wires to top & bottom terminals on gas valve.
5. Re-install log set. Page 13.
6. Re-install glass assembly. Page 7.
7. Verify proper log placement, operation of fireplace, and any electrical components.

CAUTION

CHECK ALL CONNECTIONS FOR LEAKS WITH SOAPY WATER, WHETHER FIELD OR FACTORY MADE.

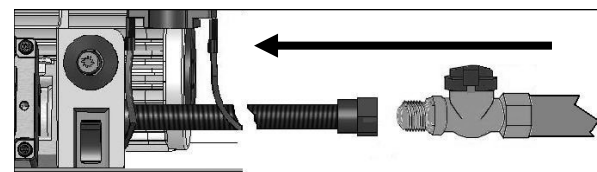
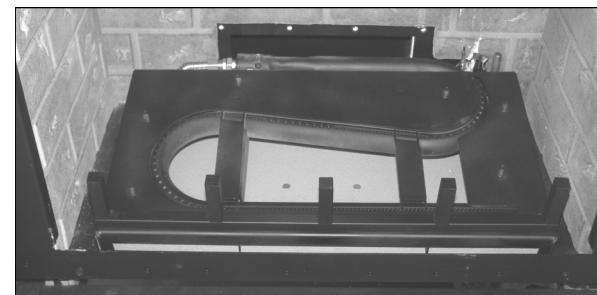
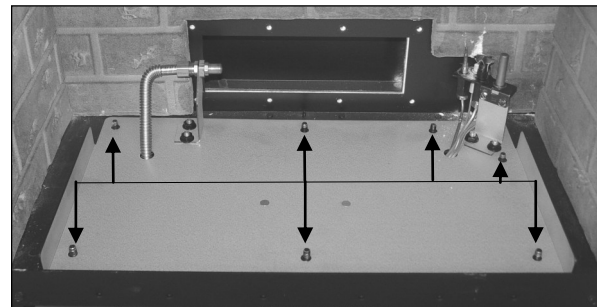
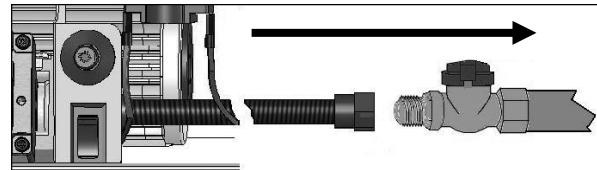
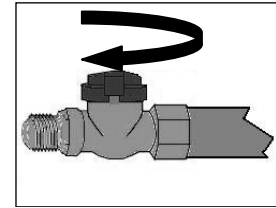

RE-CONNECT ANY REMOTE / THERMOSTAT WIRES

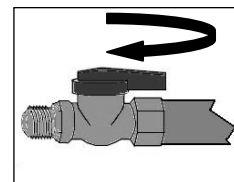
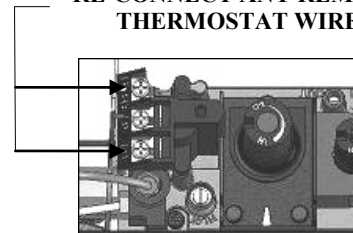

Figure 14a

FINALIZING THE INSTALLATION

FLAME APPEARANCE:

Flame appearance is affected by several factors including altitude, venting configuration and fuel quality. Although the venturi setting has been factory set, adjustments may be necessary for optimal performance and visual aesthetics.

When fireplace is first lit, the flames will be blue, gradually turning yellowish-orange during first 15 minutes of operation. If flames remain blue or become dark orange with evidence of sooting (black tips), the burner tube venturi may need adjustment.

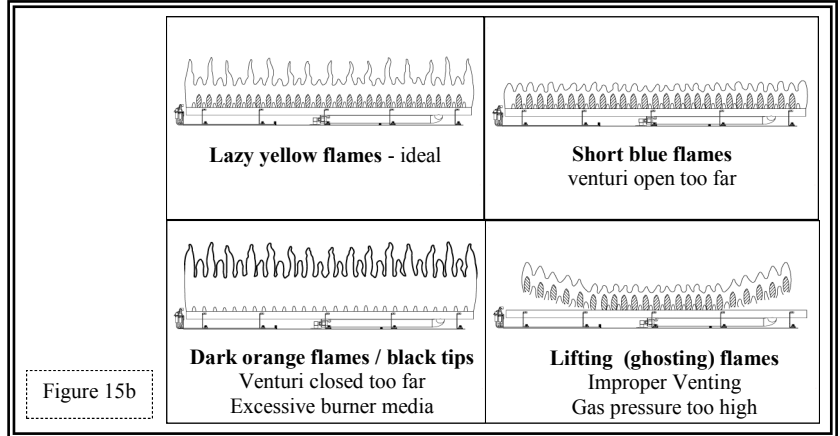
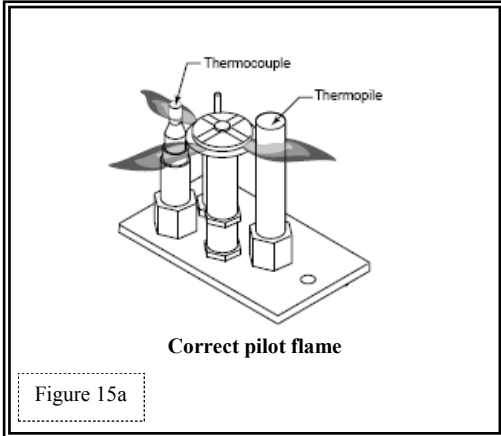

WARNING

Burner tube adjustable venturi positioning should only be performed by a qualified professional service technician.

FACTORY SET BURNER TUBE VENTURI SETTINGS (ADJUST AS NECESSARY FOR YOUR INSTALLATION)

NATURAL GAS	LP (PROPANE) GAS
3/16" (5mm) OPEN	5/8" (16mm) OPEN

BURNER TUBE VENTURI ADJUSTMENT GUIDELINES

VENTURI POSITION	FLAME COLOR	VENTURI ADJUSTMENT
Closed too far	Dark orange flame with black tips	Open venturi setting slightly
Open too far	Blue flames	Close venturi setting slightly

NOTE

If soot is present, check log positioning before adjusting burner venturi. Logs must not block burner ports.

IMPORTANT

SLIGHT ADJUSTMENTS TO THE BURNER VENTURI OPENING CREATE DRAMATIC RESULTS. ADJUST AT SLIGHT INCREMENTS UNTIL DESIRED LOOK IS ACHIEVED. ALWAYS BURN FIREPLACE FOR AT LEAST 15 MINUTES AND ALLOW TIME TO COOL BEFORE MAKING ANY FURTHER ADJUSTMENTS.

TO ADJUST VENTURI:

1. Remove glass frame assembly. Page 7.
2. Remove log set.
3. Remove burner assembly. Refer to page 14.
4. Loosen screw on burner venturi and adjust as necessary. Tighten screw.
5. Reinstall all components previously removed.
6. Light fireplace and wait 15 minutes before determining if any further adjustments are needed.

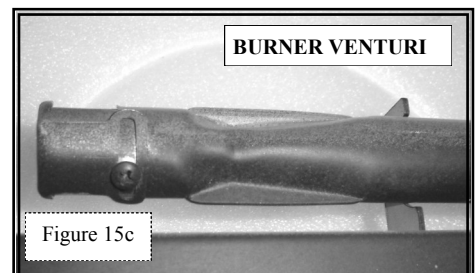

FINALIZING THE INSTALLATION

RESTRICTOR USAGE:

Turn fireplace on and allow to burn for 15 minutes. If flames indicate there is excessive draft (flickering, short flames) or insufficient draft (lifting or ghosting flames) a restrictor may be necessary, or previously installed restrictor may need to be modified or removed.

WARNING

TO AVOID PROPERTY DAMAGE OR PERSONAL INJURY, ALLOW FIREPLACE AMPLE TIME TO COOL BEFORE MAKING ANY ADJUSTMENTS AND / OR INSTALLATIONS.

RESTRICTOR TROUBLESHOOTING

FLAME APPEARANCE	DRAFT PROBLEM	RESTRICTOR SOLUTION
Short, flickering	Excessive draft - not enough restriction	Add restrictor
Lifting or ghosting ^a	Insufficient draft - too much restriction	Remove inner ring (s) on restrictor or remove restrictor

^a Improper venting installation may cause flames to lift or “ghost” - a dangerous situation. Inspect flames after installation to ensure proper performance. If it is determined that venting is correct and the restrictor has been removed, yet flames are still lifting or ghosting, shut off gas supply to fireplace and call a qualified service technician.

RESTRICTOR INSTALLATION / MODIFICATION (after termination completion):

If it is determined that a restrictor is needed or restrictor modification is required after termination is installed, access can be reached through the fireplace baffle. Please remove logs and refractory to avoid damaging these components.

1. Remove (2) nuts securing baffle. Remove baffle to expose venting.
2. Depending on your specific needs, determined by chart above along with other factors, make necessary modifications.
3. If installation of a restrictor (included in components packet) is necessary, bend tabs on restrictor to approx. 80 degree angles to create tension when inserted into exhaust pipe on fireplace. Insert restrictor into 4” exhaust pipe with tabs pointing towards you.
4. If modification is necessary, remove restrictor by pulling it down and out of 4” exhaust pipe.
5. Reinstall baffle, secure with (2) nuts previously removed.
6. Reinstall refractory and log set.
7. Attach glass frame assembly and light fireplace. Wait 15 minutes before determining if any further modifications are necessary.

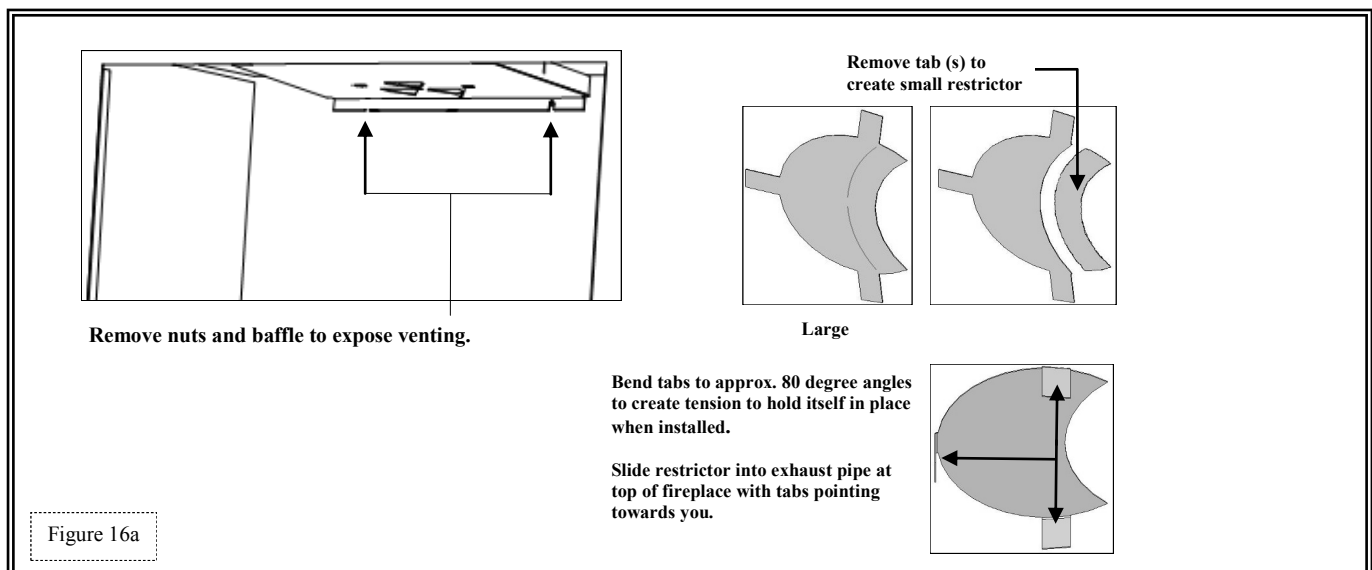

FINALIZING THE INSTALLATION

SEASONAL HEAT DUMP

This fireplace insert has been manufactured with a heat dump damper located at the inside top of firebox. This allows infinite control over amount of heat emitted into living areas without affecting flame height.

INSTALLER: Please install this fireplace insert with heat dump in closed position.

HOMEOWNER: This fireplace insert has been installed with heat dump in closed position and will operate at its peak efficiency at this setting. The heat dump may be opened as much as necessary to maintain desired heat level.

CAUTION

DO NOT ATTEMPT ADJUSTMENT IF FIREPLACE HAS BEEN IN OPERATION. ALLOW AMPLE TIME TO COOL OR USE APPROPRIATE PROTECTION TO AVOID SERIOUS BURNS AND / OR PROPERTY DAMAGE.

Remove glass frame assembly, open or close heat dump as desired, re-install glass frame assembly.

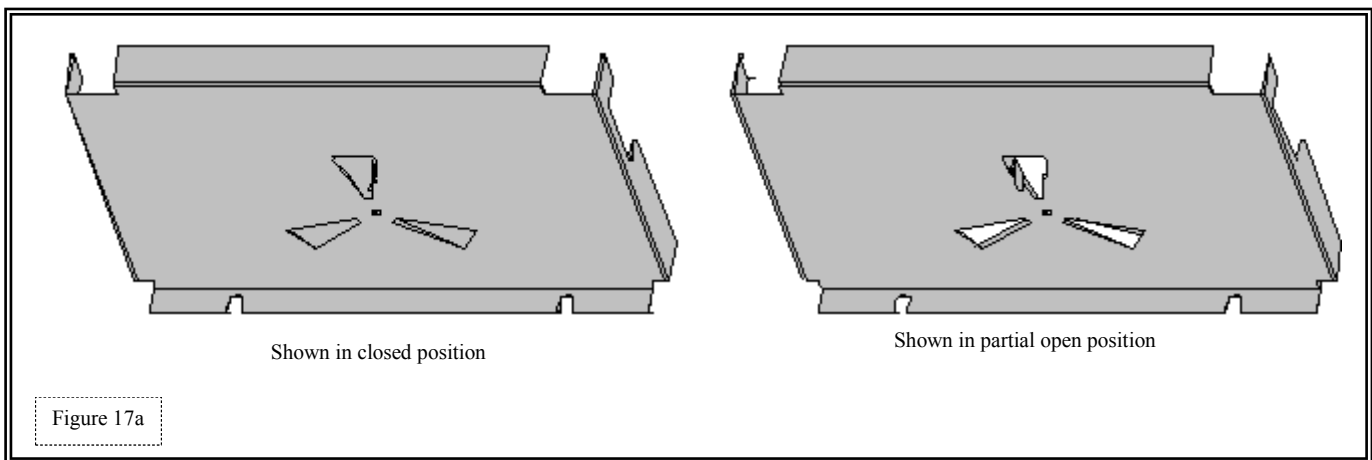

MAINTENANCE

The appliance is required to be inspected at least once a year by a professional service person.

The compartment below firebox must be cleaned at least once a year, more frequent cleaning may be required due to excessive lint from carpeting, bedding materials, or other fibrous materials. Use a vacuum to clean all components at least once a year.

NOTE

INSTALLATION AND REPAIR SHOULD BE DONE ONLY BY QUALIFIED SERVICE PERSON. THE APPLIANCE SHOULD BE INSPECTED BEFORE USE AND ANNUALLY BY A QUALIFIED SERVICE PERSON. MORE FREQUENT CLEANING MAY BE REQUIRED DUE TO EXCESSIVE LINT FROM CARPETING, BEDDING MATERIALS, ETC. IT IS IMPERATIVE THAT CONTROL COMPARTMENTS, BURNERS AND CIRCULATION AIR PASSAGEWAYS OF THE APPLIANCE BE KEPT CLEAN.

CONTROL BOARD SYSTEM

- Annual cleaning of the burner system is required. Vacuum all components thoroughly.
- The burner assembly may be removed for easier access. Refer to page 14 in this installation manual for complete instruction on removing & reinstalling the burner assembly.
- Visually check for blocked port holes, especially near the pilot. Blocked port holes may cause delayed ignition.
- Reinstall burner assembly following instructions on page 14 of this installation manual.
- Visually check pilot light and burner when in operation. The flames should be steady, not lifting or floating.

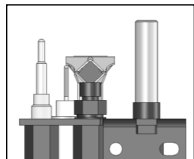

Pilot

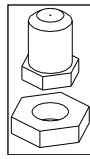

Burner Orifice

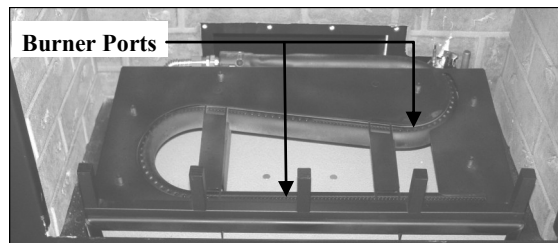

Figure 18a

FAN

The fan should be disconnected from electrical current, and cleaned (vacuumed) every six months. The bearings are sealed and require no oiling.

VENT SYSTEM

Annual examination of venting system by a qualified agency is required.

IF VENT-AIR INTAKE SYSTEM IS DISASSEMBLED FOR ANY REASON, RE-INSTALL PER INSTRUCTIONS PROVIDED WITH INITIAL INSTALLATION.

The flow of combustion and ventilation air must not be obstructed.

GLASS CLEANING & REPLACEMENT

- Clean glass only when cool and only with non-abrasive cleansers.
WARNING: DO NOT OPERATE APPLIANCE WITH GLASS/FRAME ASSEMBLY REMOVED, CRACKED OR BROKEN. REPLACEMENT OF THE GLASS SHOULD ONLY BE PERFORMED BY A LICENSED OR QUALIFIED SERVICE PERSON.
- Use protective gloves to handle any broken or damaged glass assembly components.
- The glass assembly, part #700-015T, shall only be replaced as a complete unit, as supplied by Hussong Mfg. Co., Inc.
- Replacement of glass & frame assembly, part #700-015T, must only be performed by a licensed or qualified service person.
DO NOT SUBSTITUTE MATERIALS.
- Do not strike or slam glass door assembly.

IMPORTANT

ANY SAFETY SCREEN OR GUARD REMOVED FOR SERVICING MUST BE REPLACED PRIOR TO OPERATING THE APPLIANCE.

CAUTION

LABEL ALL WIRES PRIOR TO DISCONNECTION WHEN SERVICING CONTROLS. WIRING ERRORS CAN CAUSE IMPROPER AND DANGEROUS OPERATION. VERIFY PROPER OPERATION AFTER SERVICING.

KEEP APPLIANCE AREA CLEAR OF COMBUSTIBLE MATERIALS, SUCH AS GASOLINE AND OTHER FLAMMABLE VAPORS AND LIQUIDS.

LIMITED WARRANTY

KOZY HEAT LIMITED 10 YEAR WARRANTY

This limited 10 Year Warranty will not become effective until the Warranty Registration Form has been completed and mailed to Hussong Manufacturing Co., Inc., P.O. Box 577, Lakefield, MN 56150. This registration form must be received within 30 days of installation. Failure to do so may result in delayed warranty coverage and submission of proof of purchase will be required.

Hussong Manufacturing Co., Inc. warranties to the original purchaser of this Kozy Heat Fireplace, that it is free of defects in materials and workmanship at the time of manufacture.

Subject to the following conditions & requirements, Hussong Manufacturing Co., Inc. extends the following limited warranty under normal use and service, with respect to the Kozy Heat line of gas burning fireplaces.

YEAR 1: Subject to the conditions & requirements listed below, within the first year from date of purchase, Hussong Manufacturing Co., Inc. shall, at its discretion, replace or repair any such defect in material or workmanship, at Hussong Manufacturing Co., Inc.'s expense, including reasonable labor costs to repair or replace the defective component, if a factory pre-authorization is given for the repair.

YEARS 2-10: Subject to the conditions & requirements listed below, beginning with the first day of the second year and continuing through the tenth year, Hussong Manufacturing Co., Inc., will at its discretion, provide repair or replacement parts at current list prices for any defect in material or workmanship of components, including optional components and accessories (if available). Hussong Manufacturing Co., Inc. shall not be responsible for any installation, labor, transportation of other indirect costs.

LIMITATION OF LIABILITY

To make a claim under this warranty, the purchaser must first contact the dealer/installer from whom the fireplace was purchased.

This limited warranty will be void if the fireplace is not installed by a qualified installer and according to the installation instructions. Use of unauthorized components will make this warranty null and void.

This limited warranty also is void if the fireplace is not operated, at all times, according to the operating instructions furnished.

This warranty is limited to defects in material and workmanship. It does not apply to any product that has been subject to negligence, misapplication, improper installation.

No person is authorized to extend the time of this warranty or to accept on Hussong Manufacturing Co., Inc.'s behalf any additional obligation of liability connected with the unit.

It is expressly agreed and understood that this warranty is Hussong Manufacturing Co., Inc.'s sole obligation and purchaser's exclusive remedy for defective fireplace equipment. Hussong Manufacturing Co., Inc. shall not be liable for any consequential, incidental or contingent damages whatsoever. The foregoing warranty is exclusive and in lieu of all other expressed warranties. Hussong Manufacturing Co., Inc. shall not be held to implied warranties or merchantability and fitness for a particular purpose. This warranty replaces all previous warranty policies.

Some states do not allow the exclusion or limitation of incidental or consequential damages or limitations on how long an implied warranty lasts, so the above limitations or exclusions may not apply to you. This warranty gives you specific legal rights and you may also have other rights which vary from state to state.

Hussong Manufacturing Co., Inc. reserves the right to make changes at any time, without notice, in design, material, specifications and prices. Hussong Manufacturing Co., Inc. reserves the right to discontinue models and products.

WARRANTY CONDITIONS & REQUIREMENTS:

1. You are the original purchaser. This warranty is not transferable.
2. Installation of the fireplace is performed by a qualified installer.
3. Installation and operation must comply with installation and operation instructions.
4. Paint and glass gaskets are covered for 30 days from date of purchase.
5. Remote controls and all optional accessories are covered for 1 year from date of purchase.
6. This warranty does not offer coverage for Light Bulbs or Batteries (whether factory, dealer or installer supplied). This includes any damage stemming from either component's nonuse.
7. Components broken, (including glass panels), during shipping, careless handling of components, or defects resulting from improper installation, misuse of the fireplace and components are not covered under this warranty.
8. This warranty does not cover any part of the fireplace or any components which have been exposed to or submerged under water.
9. Hussong Manufacturing Co., Inc. must be notified by the dealer the fireplace was purchased from or a qualified installer/service technician of the defect.
10. Annual service of the fireplace as required in the installation manual, is performed by a qualified installer/service technician. (Copies of such service records may be required to claim a warranty).
11. All previous warranty/service has been performed by a qualified installer or service technician. (Copies of such service records may be required to claim a warranty).

LIFETIME WARRANTY

LIFETIME WARRANTY

THIS LIFETIME WARRANTY COVERAGE WILL BE EXTENDED AS DESCRIBED BELOW PROVIDED ALL WARRANTY CONDITIONS AND REQUIREMENTS ARE MET AS OUTLINED IN THE 10 YEAR LIMITED WARRANTY POLICY.

LIFETIME WARRANTY COVERAGE

LIFETIME WARRANTY IS EXTENDED AS FOLLOWS: Hussong Manufacturing Co., Inc. warrants to the original purchaser that the firebox, heat exchanger, fiber logs, burner tube and glass panel of this Kozy Heat Fireplace will not be defective in material or workmanship under normal use and service for as long as you own this product. If any of these components fail due to defects in material and workmanship under normal use and service, Hussong Manufacturing, Co., Inc. will, at its sole discretion, repair or replace the defective component. This LIFETIME WARRANTY does not cover any installation, labor, transportation or other indirect cost arising from defective components.

LIMITATION OF LIABILITY

This Lifetime Warranty will be void if the fireplace is not installed by a qualified installer and according to the installation instructions. Use of unauthorized components will make this warranty null and void. This Lifetime Warranty also is void if the fireplace is not operated, at all times, according to the operating instructions furnished. This warranty is limited to defects in material and workmanship of components specified. It does not apply to any product that has been subject to negligence, misapplication, improper installation.

No person is authorized to extend the time of this Lifetime Warranty or to accept on Hussong Manufacturing Co., Inc.'s behalf any additional obligation of liability connected with the unit .

Hussong Manufacturing Co., Inc. may fully discharge all obligations with respect to this Lifetime Warranty by refunding the wholesale price of the defective component(s).

It is expressly agreed and understood that this Lifetime Warranty is Hussong Manufacturing Co., Inc.'s sole obligation and original purchaser's exclusive remedy for defective fireplace equipment. Hussong Manufacturing Co., Inc. shall not be liable for any consequential, incidental or contingent damages whatsoever other than those incurred by Hussong Manufacturing Co., Inc. to repair or replace the defective component. The foregoing warranty is exclusive and in lieu of all other expressed warranties. Hussong Manufacturing Co., Inc. shall not be held to implied warranties, including but not limited to the implied warranties of merchantability and fitness for a particular purpose. This lifetime warranty replace all previous lifetime warranty policies.

Hussong Manufacturing Co., Inc. reserves the right to make changes at any time, without notice, in design, material, specifications and prices. Hussong Manufacturing Co., Inc. reserves the right to discontinue models and products.

To activate this Lifetime Warranty coverage, this registration card must be completed and mailed with your completed 10 Year Limited Warranty form within 30 days of installation to the following address:

***Hussong Manufacturing Co., Inc.
P.O. Box 577
204 Industrial Park Drive
Lakefield, MN 56150-0577***

Sept. 2011

CUT ALONG DOTTED LINE

PURCHASER NAME: _____
ADDRESS: _____

TELEPHONE: _____

INSTALLATION DATE: _____
MODEL #: _____
SERIAL #: _____

INSTALLER NAME: _____
ADDRESS: _____

TELEPHONE: _____



Supplemental Installation and Homeowner Information Manual for Lakefield Model:

56150

FREE-STANDING DIRECT VENT GAS FIREPLACE



English and French Installation Manuals Available Through Your Local Dealer or Visit Our Website at www.kozyheat.com

Les manuels d'installation en anglais et en français sont disponibles chez votre détaillant local ou en visitant notre site Web : www.kozyheat.com

IMPORTANT: This supplemental installation and homeowner manual is to be used in conjunction with LAKEFIELD INSTALLATION MANUAL. Read both manuals before installing and operating appliance.

INSTALLER: Leave this manual with the appliance.
CONSUMER: Retain this manual for future reference.

WARNING: Improper installation, adjustment, alteration, service or maintenance can cause injury or property damage. Refer to fireplace installation manual and this manual. For assistance or additional information consult a qualified installer, service agency or the gas supplier.

WARNING: If the information in these instructions is not followed exactly, a fire or explosion may result causing property damage, personal injury or loss of life.

– Do not store or use gasoline or other flammable vapors and liquids in the vicinity of this or any other appliance.

WHAT TO DO IF YOU SMELL GAS:

- ☐ Do not try to light any appliance.
- ☐ Do not touch any electrical switch: do not use any phone in your building.
- ☐ Immediately call gas supplier from a neighbors phone. Follow the gas supplier instructions.
- ☐ If you cannot reach your gas supplier, call the fire department.

– Installation and service must be performed by a qualified installer, service agency or the gas supplier.



WARNING



**HOT GLASS WILL CAUSE BURNS.
DO NOT TOUCH GLASS UNTIL COOLED.
NEVER ALLOW CHILDREN TO TOUCH GLASS.**



JULY 2012
LKF-SUP-REV-01

TABLE OF CONTENTS

<u>SAFETY INFORMATION</u>	
Safety Information	2
<u>SPECIFICATIONS</u>	
Components List	3
Gas Pressure Requirements / BTU's	3
<u>THERMOSTAT / WALL SWITCH / REMOTE</u>	
Thermostat / Wall Switch / Remote	4
<u>OPERATING INSTRUCTIONS</u>	
Valve and Pilot Assembly Components	5
Lighting and Shutdown Instructions	6-8
Pressure Testing	9
<u>TROUBLESHOOTING</u>	
Troubleshooting	10-12
<u>CONVERSION KIT INSTRUCTIONS</u>	
Conversion Kit Instructions	13-15
<u>MAINTENANCE</u>	
Maintenance	16
<u>REPLACEMENT PARTS</u>	
Replacement Parts	17

SAFETY INFORMATION

This fireplace has been tested by PFS Corporation, Madison, Wisconsin and complies with:

ANSI Z21.88-2009/CSA 2.33-2009, "Standard for Vented Gas Fireplace Heaters."

CAN 2.14-M91, "Gas-Fired for Use at High Altitudes."

CAN/CSA P.4.1-02, "Testing Method for Measuring Annual Efficiency".

This installation must conform with local codes, or in the absence of local codes, with the *National Fuel Gas Code, ANSI Z223.1/NFPA 54*, or the *Natural Gas and Propane Installation Code, CSA B149.1*

- Installation and repair should be done only by a qualified service person. The appliance should be inspected by a qualified service person before use. Annual inspection by a qualified service person is required to maintain warranty. More frequent cleaning may be required due to excessive lint from carpeting, bedding materials, etc. It is imperative that control compartments, burners and circulation air passageways of the appliance be kept clean.
- If this appliance is installed directly on carpeting, tile or other combustible material other than wood flooring, the appliance shall be installed on a metal or wood panel extending the full width and depth of the appliance.
- Children and adults should be alerted to the hazards of high surface temperatures and should stay away to avoid burns or clothing ignition.
- Young children should be carefully supervised when they are in the same room as the appliance. Toddlers, young children and others may be susceptible to accidental contact burns. A physical barrier is recommended if there are at risk individuals in the house. To restrict access to a fireplace or stove, install an adjustable safety gate to keep toddlers, young children and other at risk individuals out of the room and away from hot surfaces.
- Clothing or other flammable material should not be placed on or near the appliance.
- Adequate accessibility clearances for servicing and proper operation must be maintained.
- This appliance must not share or be connected to a chimney flue serving any other appliance.
- Keep area around the appliance clear of combustible materials, gasoline and other flammable vapor and liquids.
- The flow of combustion and ventilation air must not be obstructed.
- Due to high temperatures the appliance should be located out of traffic and away from furniture and draperies.
- The glass front or any part removed for servicing the appliance must be replaced prior to operating the appliance. Work should be done by a qualified service technician.
- Clean glass only when cool and only with non-abrasive cleansers.
- **WARNING: DO NOT OPERATE APPLIANCE WITH THE GLASS/FRAME ASSEMBLY REMOVED, CRACKED OR BROKEN. REPLACEMENT OF THE GLASS SHOULD ONLY BE PERFORMED BY A LICENSED OR QUALIFIED SERVICE PERSON.**
- The glass assembly, Part #700-015T, shall only be replaced as a complete unit, as supplied by Hussong Mfg. Co., Inc. DO NOT SUBSTITUTE MATERIALS.
- Do not strike or slam glass assembly.
- Any safety screen or guard removed for servicing the appliance must be replaced prior to operating the appliance.
- Under no circumstances should any solid fuel (wood, coal, paper or cardboard etc.) be used in this appliance.
- Keep burner and control compartment clean.
- Do not use this fireplace if any part has been under water. Immediately call a qualified service technician to inspect this appliance and to replace any part of the control system and any gas control which has been under water.

SPECIFICATIONS

COMPONENTS LIST

PART NUMBER	DESCRIPTION
LKF-770	Millivolt Control Board Assembly
700-203	Manual Gas Shut-off Valve
LKF-G900	Refractory Set
BRK-500	Log Package
LKF-005	Glass Valance
700-015T	Glass with Gasket
600-083	Receptacle / Speed Control Assembly
900-085	4" Restrictor Plate

	<u>NATURAL GAS</u>	<u>LP GAS</u>
MINIMUM INLET GAS PRESSURE	5" W.C. (1.25 kPa) (7" W.C. (1.74 kPa) recommended)	11" W.C. (2.74 kPa) (recommended)
MAXIMUM INLET GAS PRESSURE	10.5" W.C. (2.62 kPa)	13" W.C. (3.24 kPa)
MANIFOLD PRESSURE (HI)	3.8 inches W.C. (.95 kPa)	11" W.C. (2.74 kPa)
MANIFOLD PRESSURE (LO)	1.1 inches W.C. (.27 kPa)	6.3 inches W.C (1.57 kPa)
ORIFICE SIZE	#33	#52
INPUT	33,000 BTU/hr. (9.67 kW)	31,500 BTU/hr. (9.23 kW)
MINIMUM INPUT	16,500 BTU/hr. (4.84 kW)	15,750 BTU/hr. (4.62 kW)

OPTIONAL FAN KIT

INSTALLATION OF THIS FAN SHOULD BE DONE ONLY BY A QUALIFIED INSTALLER

This optional #LKF-028 fan kit includes:

- Right & left fan assemblies - mounted
- Temperature control switch with magnet attached
- Speed Control Box with 8ft. cord
- Fan cover plate
- (4) Flange nuts
- (4) Phillips head screws (black)

WARNING

MAKE SURE HOUSEHOLD BREAKER IS SHUT OFF PRIOR TO WORKING ON ANY ELECTRICAL LINES.

This appliance is equipped with a three-prong (grounding) plug for protection against shock hazard and should be plugged into a properly grounded three-prong receptacle. Do not cut or remove grounding prong from plug.

NOTE

This appliance must be electrically grounded and connected in accordance with local codes, or in the absence of local codes, with the National Electrical Code, ANSI/NFPA 70 Current Edition, or the Canadian electrical Code CSA C22.1.

This fan will not operate unless speed control has been turned ON and sufficient heat has been applied to temperature control switch. The fan will turn ON and OFF automatically as fireplace heats and cools. Adjust fan to desired speed while it is running.

We recommend that an electrical outlet be installed near fireplace.

1. Locate (4) mounting studs underneath rear of fireplace.
2. Slide fan underneath fireplace, lift up, aligning (4) mount holes / slots in fan bracket to mounting studs under firebox. Secure with (4) nuts (included).
3. Attach fan cover to back of fireplace by aligning holes in cover to holes at back of fireplace. Secure with remaining (2) screws.
4. Mount speed control box onto left side of gas valve bracket by aligning slots in box to holes in bracket. Secure with (2) black phillips head screws, included.
5. Place temperature control switch (magnet attached) onto bottom of firebox as close to center as possible.
6. Plug fan cord into receptacle on speed control box.
7. Plug speed control box cord into a properly grounded three-prong receptacle.
8. Turn speed control counter-clockwise until it clicks. This is the OFF position.
9. Turn speed control ON by turning knob clockwise past click - this is the highest setting.

TEMPERATURE CONTROL SWITCH POSITION

Before adjusting temperature control switch, unplug 3-prong plug on fan cord from receptacle. Adjust position of temperature control switch to a warmer location under firebox to turn fan ON sooner or move it to a cooler location under firebox to turn fan ON later. The fan will turn on when sensor in temperature control switch reaches 110° F and will turn OFF when sensor reaches 90° F. After adjustment, plug 3-prong plug on fan cord into receptacle.

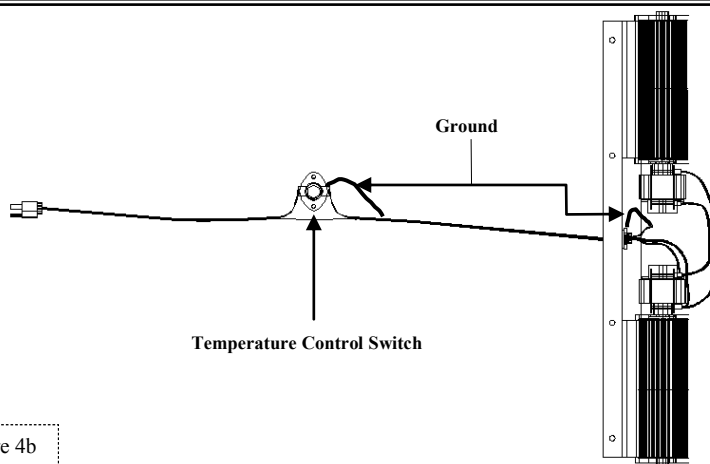

Figure 4b

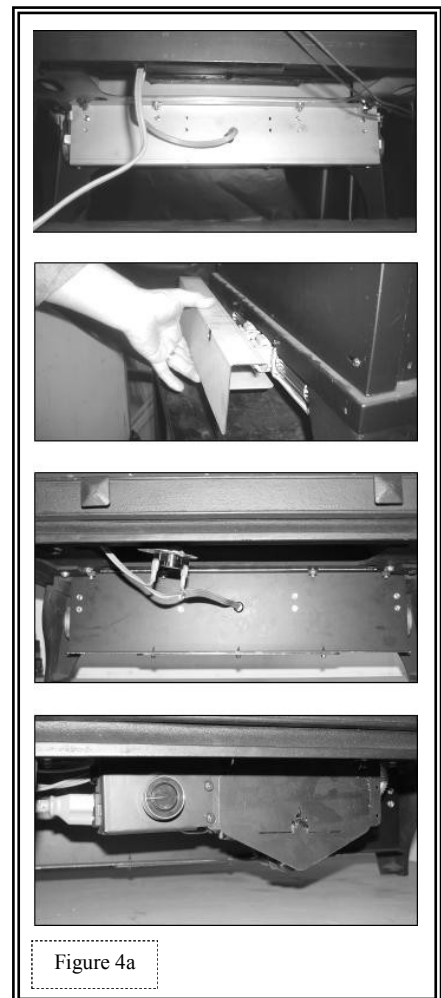

Figure 4a

THERMOSTAT / WALL SWITCH / REMOTE

If desired, a thermostat (wireless style also available), wall switch, or remote control assembly may be used to turn fireplace OFF and ON. Only ONE of these may be installed. Follow instructions included with chosen assembly.

NOTE

INSTALLATION OF THERMOSTAT OR WALL SWITCH SHOULD ONLY BE PERFORMED BY A QUALIFIED INSTALLER.

CAUTION

DO NOT CONNECT HIGH VOLTAGE (115V) WIRE TO THE GAS VALVE!

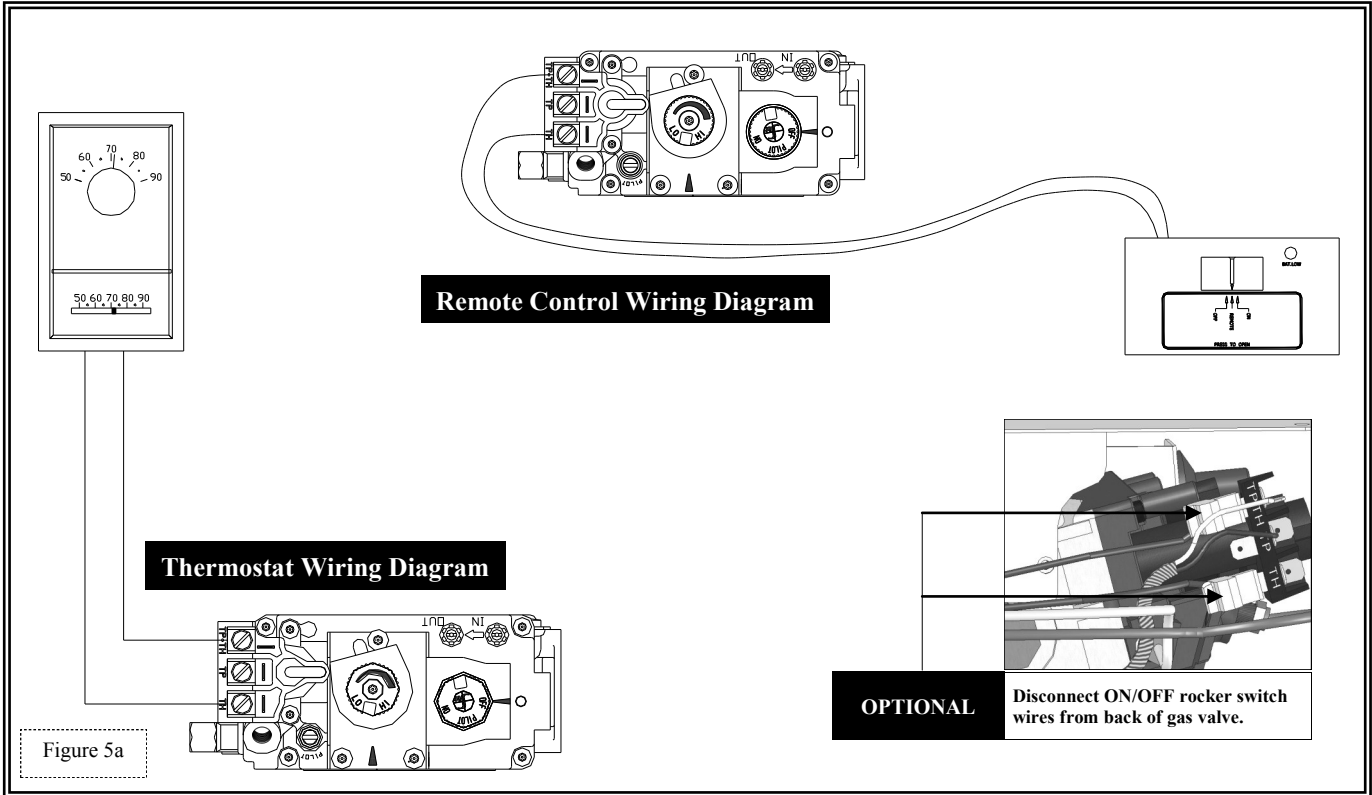

WALL SWITCH / THERMOSTAT:

Run low-voltage (thermostat) wires from terminals on gas valve to desired location of wall switch or thermostat.

Attach appropriate connectors to wall switch / thermostat wires and connect to top and bottom terminals marked TH/TPH on gas valve.

REMOTE CONTROL:

Follow instructions included with remote control.

IMPORTANT

If ON/OFF rocker switch wires are not disconnected, the ON/OFF rocker switch on millivolt board must be in OFF position for proper operation of any of these components.

If rocker switch is ON, fireplace burner will operate until it is turned OFF by rocker switch. A wall switch, thermostat, or remote control will not turn fireplace OFF when it has been turned ON by the rocker switch.

NOTE

Fireplace must be turned ON and OFF by same method. For example: If fireplace is turned ON by remote control, it must be turned OFF by remote control.

IMPORTANT

The insulated cover included with remote control must be placed over remote receiver to prevent overheating.

VALVE & PILOT ASSEMBLY COMPONENTS

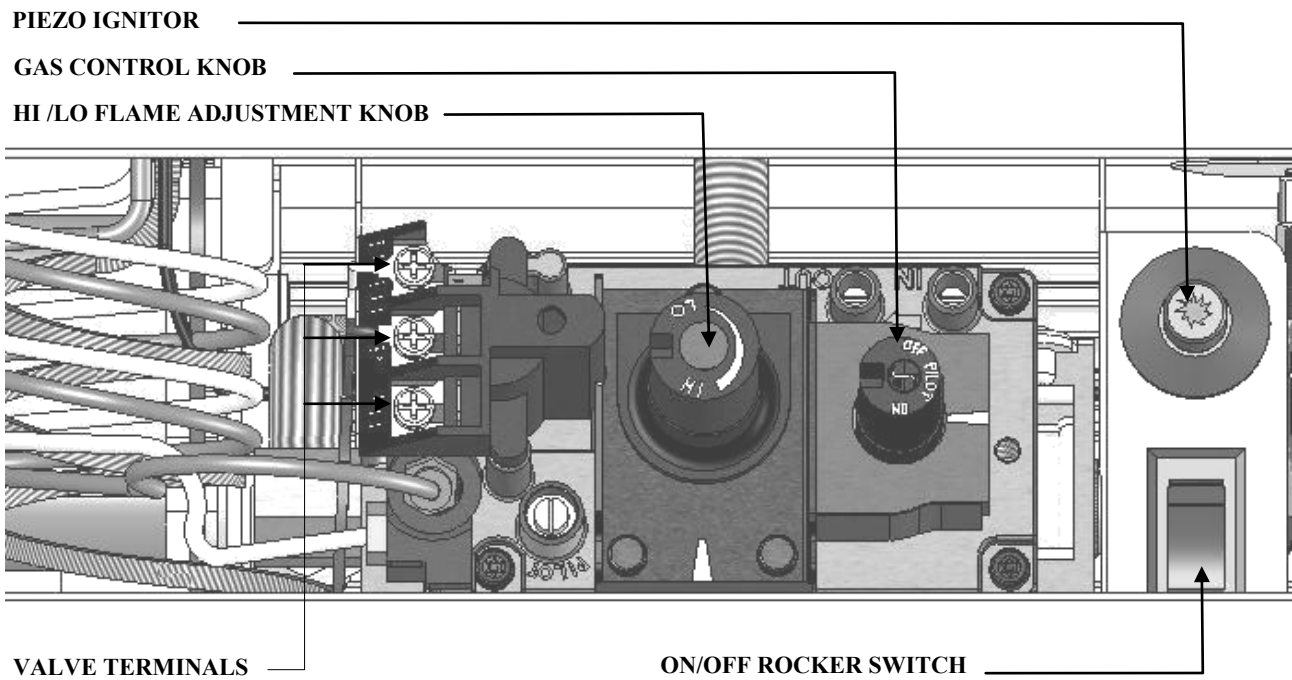
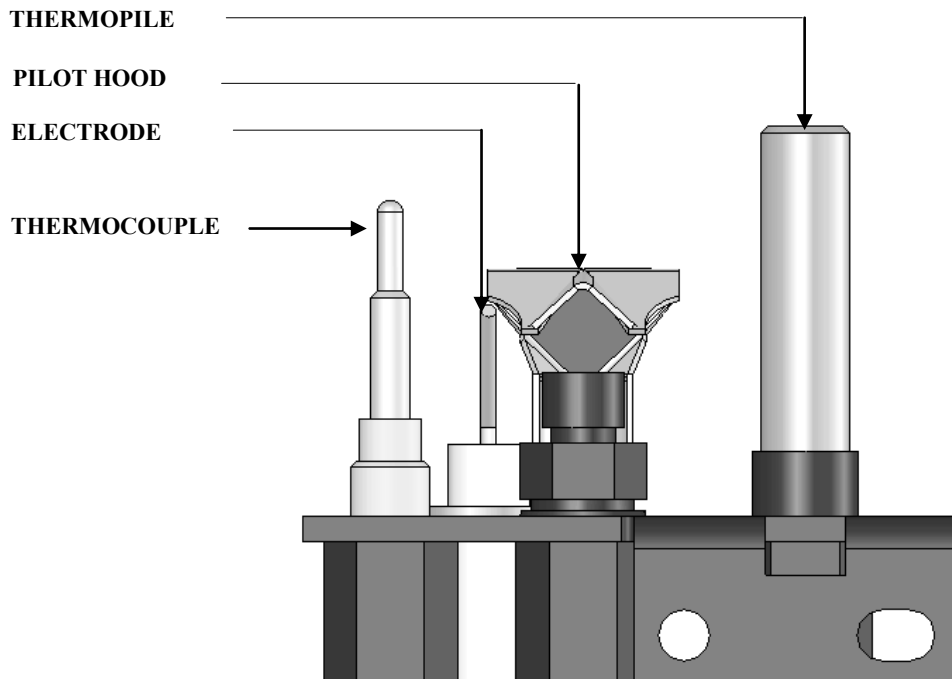

Figure 6a

LIGHTING AND SHUTDOWN

FOR YOUR SAFETY - READ BEFORE LIGHTING

WARNING

IF YOU DO **NOT** FOLLOW THESE INSTRUCTIONS EXACTLY, A FIRE OR EXPLOSION MAY RESULT, CAUSING PROPERTY DAMAGE, PERSONAL INJURY OR LOSS OF LIFE.

DUE TO HIGH SURFACE TEMPERATURES, KEEP CHILDREN, CLOTHING AND FURNITURE AWAY.

This appliance needs fresh air for safe operation and must be installed so there are provisions for adequate combustion and ventilation air.

- A. This appliance has a pilot which must be lighted by hand. When lighting the pilot, follow these instructions exactly.
- B. BEFORE LIGHTING, smell all around the appliance area for gas. Be sure to smell next to the floor because some gas is heavier than air and will settle on the floor.

WHAT TO DO IF YOU SMELL GAS:

- * Do not try to light any appliance.
 - * Do not touch any electrical switch; do not use any phone in your building.
 - * Immediately call your gas supplier from a neighbor's phone. Follow the gas supplier's instructions.
 - * If you cannot reach your gas supplier, call the fire department.
- C. Use only your hand to push in or turn the gas control knob. Never use tools. If the knob will not push in, or turn by hand, do not try to repair it, call a qualified service technician. Forced or attempted repair may result in a fire or explosion, and loss of warranty.
 - D. Do not use this appliance if any part has been under water. Immediately call a qualified service technician to inspect the appliance and to replace any part of the control system which has been under water.

WARNING

DO NOT STORE OR USE GASOLINE OR OTHER FLAMMABLE VAPORS AND LIQUIDS IN THE VICINITY OF THIS OR ANY OTHER APPLIANCE.

WARNING

CHILDREN AND ADULTS SHOULD BE ALERTED TO THE HAZARDS OF HIGH SURFACE TEMPERATURES AND SHOULD STAY AWAY TO AVOID BURNS OR CLOTHING IGNITION. YOUNG CHILDREN SHOULD BE CAREFULLY SUPERVISED WHEN THEY ARE IN THE SAME ROOM AS THE APPLIANCE. CLOTHING OR OTHER FLAMMABLE MATERIAL MUST NOT BE PLACED ON OR NEAR THE APPLIANCE.

NOTE

A PAINT SMELL WILL OCCUR DURING THE FIRST FEW HOURS OF BURNING. IT IS RECOMMENDED TO LEAVE THE FAN OFF DURING THIS PERIOD TO HELP SPEED THE PAINT CURING PROCESS.

THIS FIREPLACE MAY PRODUCE NOISES OF VARYING DEGREES AS IT HEATS AND COOLS DUE TO METAL EXPANSION AND CONTRACTION. THIS IS NORMAL AND DOES NOT AFFECT THE PERFORMANCE OR LONGEVITY OF THE FIREPLACE.

LIGHTING AND SHUTDOWN (cont.)

LIGHTING INSTRUCTIONS

1. Set thermostat to lowest setting, if installed.
2. Turn off all electrical power to appliance. (Fan).
3. Open lower grill to access gas valve & controls.
4. Push gas control knob in slightly and turn clockwise to OFF.
5. Wait five (5) minutes to clear out any gas. Then smell gas, including near the floor. If you then smell gas, **STOP!** Follow **WHAT TO DO IF YOU SMELL GAS** safety information below. If you don't smell gas, go to next step.

WHAT TO DO IF YOU SMELL GAS:

- Do not try to light any appliance.
- Do not touch any electric switch; do not use the phone in your building.
- Immediately call your gas supplier from a neighbor's phone. Follow the gas supplier's instructions.
- If you cannot reach your gas supplier, call the fire department.

NOTE

Gas control knob cannot be turned from PILOT to OFF unless knob is pushed in slightly. Do not force.

6. Locate pilot - follow metal tube from gas control. (Located inside combustion chamber).
7. Push gas control knob on gas valve in slightly and turn counterclockwise to PILOT.
8. Push valve knob in and hold while repeatedly pressing piezo igniter button until pilot is lit while continuing to hold in gas control knob.
9. Hold gas control knob in for one (1) minute after pilot is lit. Release gas control knob. If pilot goes out, repeat steps 4-8. When pilot is lit, proceed to step 10.

CAUTION

If knob does not pop up when released, stop and immediately call your service technician or the gas supplier. If pilot will not stay lit after several tries, turn gas control knob to OFF and call your service technician or gas supplier.

10. Push gas control knob in slightly and turn counterclockwise to ON. The burner can now be turned ON by depressing ON/OFF rocker switch located beside valve, or wall switch, OR by setting thermostat or remote control to desired setting.
11. Turn on all electric power to appliance (if applicable).

NOTE

When fireplace is initially lit, condensation will appear on the glass; this is normal in all gas fireplaces and will disappear after several minutes.

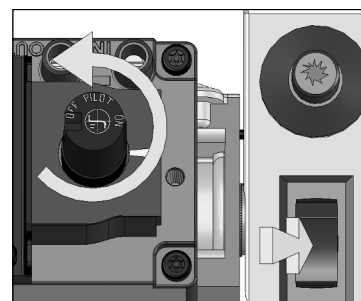
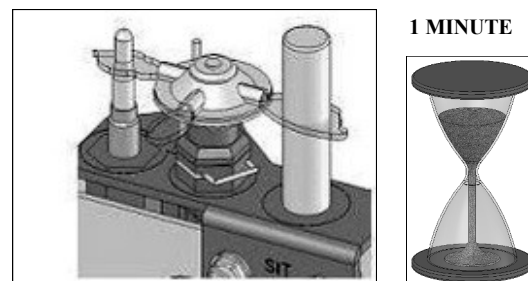
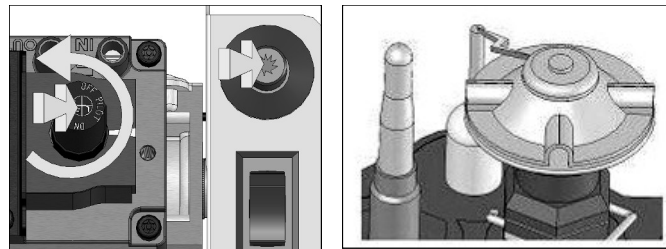
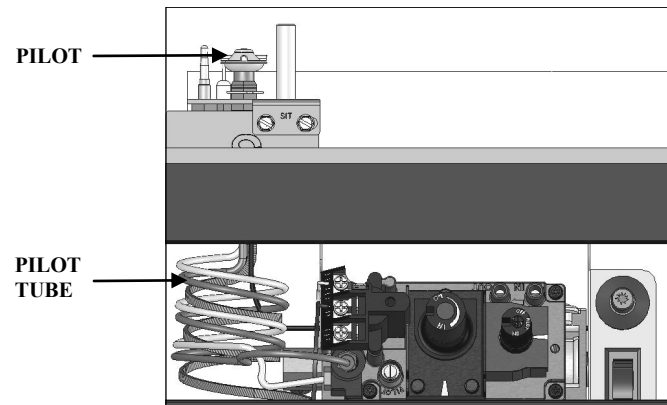
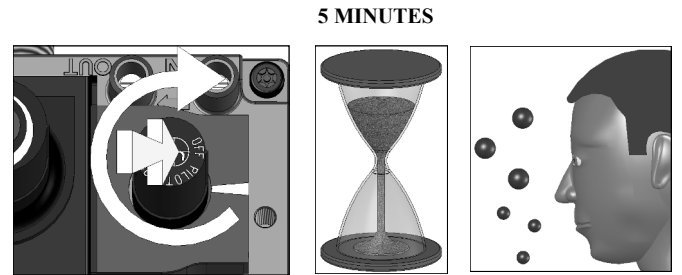

Figure 8a

LIGHTING AND SHUTDOWN (cont.)

TO TURN OFF GAS TO APPLIANCE

TURN BURNER OFF

To turn burner OFF, depress ON/OFF rocker switch to OFF, turn off wall switch or adjust setting on thermostat or remote control.

NOTE The pilot will stay lit.

TURN PILOT OFF

Turn pilot off by pushing in and turning gas control knob to OFF. **DO NOT FORCE.**

NOTE This control valve has an interlock device. If pilot has been turned off, it cannot be relit until thermocouple has cooled, (approximately 60 seconds).

ADJUSTING FLAME HEIGHT

The gas control valve has a HI /LO flame adjustment knob designed to allow you to tailor the look and heat output of your fireplace. Adjust by turning middle knob on gas control valve.

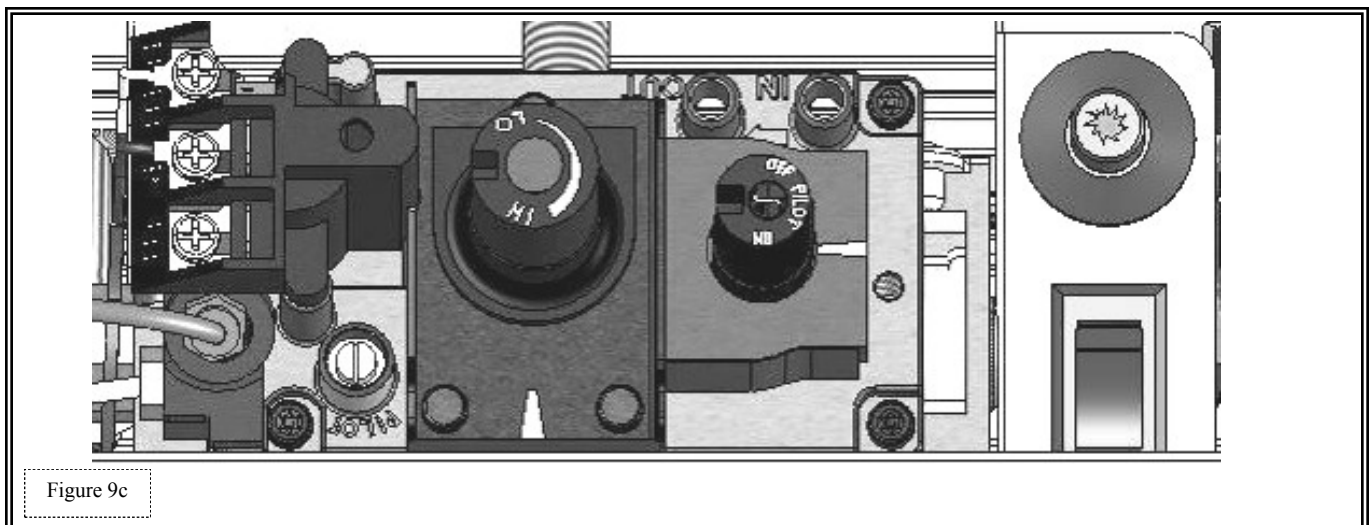
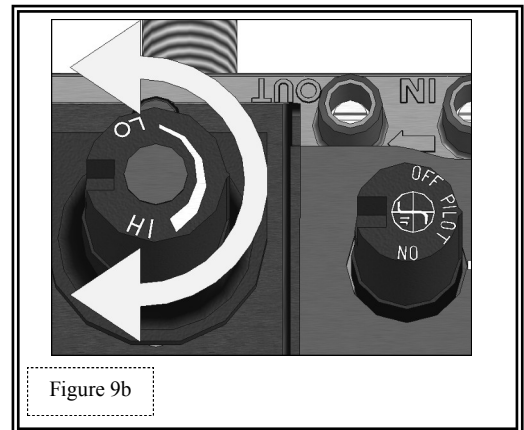
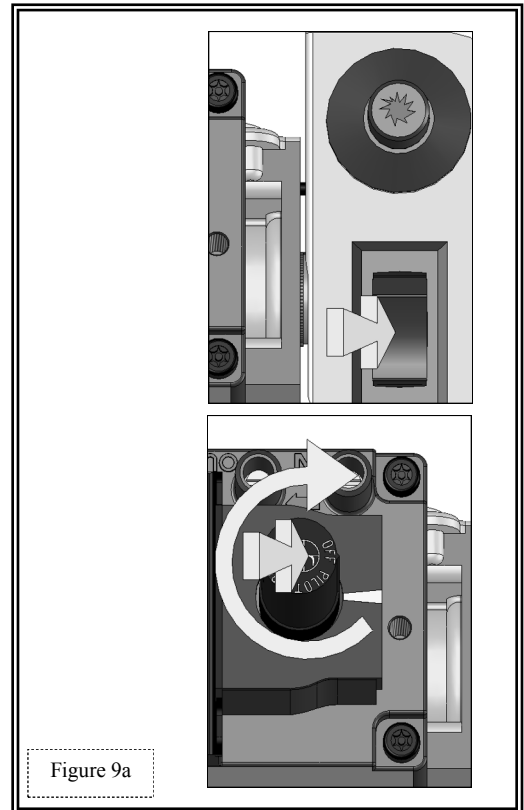

PRESSURE TESTING

IMPORTANT

Pressure check taps for manifold (outgoing) and inlet (incoming) pressure have been incorporated into the valve. The pressure tap marked OUT measures outgoing pressure and pressure tap marked IN measures incoming pressure. Follow instructions below for proper testing procedures.

NOTE

The appliance and its individual shutoff valve must be disconnected from gas supply piping system during any pressure testing of that system at pressures in excess of ½ psi (3.5 kPa).

The appliance must be isolated from the gas supply piping system by closing its individual manual shut-off valve during any pressure testing of the gas line at test pressures equal to or less than ½ psi (3.5 kPa).

INLET PRESSURE TEST:

1. Loosen inlet (IN) pressure tap screw (counter-clockwise).
2. Attach manometer using a 5/16" I.D. hose.
3. Light pilot.
4. Turn gas control knob to ON (burner should not light). Note manometer reading.
5. Press rocker switch to ON. Check pressure to ensure it stays near maximum inlet pressure.
6. Press rocker switch to OFF.
7. Turn gas control knob to OFF.
8. Disconnect hose and tighten screw (clockwise). Screw should be snug, do not over tighten.
9. Relight pilot and turn gas control knob to ON. Reattach manometer to inlet pressure tap to verify it is completely sealed. Manometer should read no pressure.

NOTE

If inlet pressure reading is too high or too low, contact the gas company. Only a qualified gas service technician should adjust the incoming gas pressure.

MANIFOLD PRESSURE TEST:

1. Light pilot.
2. Loosen manifold (OUT) pressure tap screw (counter-clockwise).
3. Attach manometer to pressure tap using a 5/16" I.D. hose.
4. Turn gas control knob to ON.
5. Press rocker switch to ON and note manometer reading.
6. Press rocker switch to OFF.
7. Disconnect manometer hose and tighten screw (clockwise). Screw should be snug, do not over tighten.
8. Attach manometer to manifold pressure tap to verify it is completely sealed. Manometer should read no pressure when rocker switch is pressed to ON.

CAUTION

A LOW PRESSURE READING CAN CAUSE DELAYED IGNITION.

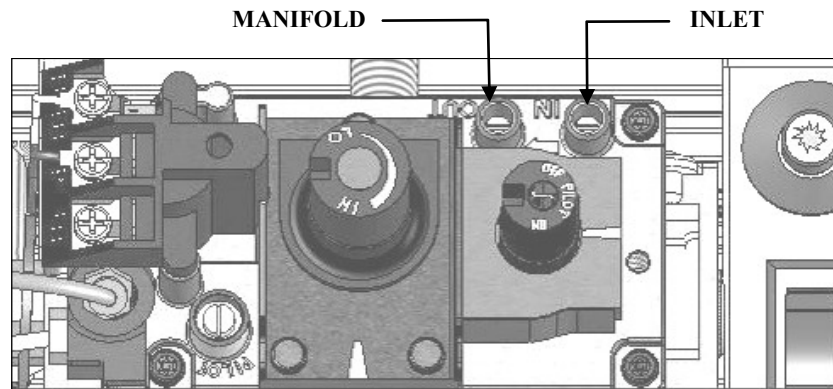

Figure 10a

TROUBLESHOOTING

CAUTION

THE FOLLOWING MUST BE PERFORMED BY A QUALIFIED TECHNICIAN.

NO SPARK FROM ELECTRODE TO PILOT WHEN PIEZO BUTTON IS TRIGGERED.

- A. Check wiring at back of piezo for proper connection.
- B. Check wiring at electrode for proper connection.
- C. Check position of electrode (1/8" (3mm) between electrode and pilot). Readjust if necessary.
- D. Look for arc below electrode and along electrode wire. Direct metal contact may cause an arc below electrode.

SPARK IGNITER WILL NOT LIGHT AFTER REPEATED TRIGGERING OF PIEZO BUTTON.

- A. No gas or low gas pressure.
 - ◆ Check remote shut off valves from fireplace. Usually there is a valve near the main. There may be more than (1) valve between the fireplace and the main.
 - ◆ Low gas pressure can be caused by several situations such as a bent line, too narrow diameter pipe, or low line pressure. Consult with plumber or gas supplier.
- B. No LP in tank.
 - ◆ Check LP (propane) tank. Refill if necessary.

PILOT WILL NOT STAY LIT AFTER CAREFULLY FOLLOWING LIGHTING INSTRUCTIONS.

- A. Check that pilot flame impinges on thermocouple. Clean and/or adjust pilot for maximum flame impingement.
- B. Ensure thermocouple connection at gas valve is fully inserted and tight (hand tight plus 1/4 turn).
- C. Thermocouple reading below 15 millivolts.
 - ◆ Disconnect thermocouple from valve, place one millivolt meter lead wire on end of thermocouple and other millivolt meter lead wire on thermocouple's copper wire. Start pilot while holding valve knob in. If millivolt reading is less than 15 millivolts, replace thermocouple.
- D. Thermopile not generating sufficient millivolts.
 - ◆ Pilot flame must be enveloping thermopile. Adjust pilot flame if necessary.
 - ◆ Check thermopile wire connections at valve. Tighten if necessary.
 - ◆ Check thermopile with millivolt meter. Turn remote / thermostat / wall switch or ON/OFF switch to OFF. Turn valve knob to PILOT position (pilot should remain lit). Take reading at THTP & TP terminals on gas valve. Reading should be 350 millivolts minimum. Replace thermopile if reading falls below specified minimum.

TROUBLESHOOTING

BURNER WILL NOT LIGHT

- A. Gas control knob not turned to ON.
- B. ON/OFF switch not turned on.
- C. Remote, wall switch or thermostat not turned ON.
- D. Plugged main burner orifice.
- E. Remote, wall switch, thermostat or ON/ OFF switch wires defective.
 - ◆ Check wires for proper connections. Place jumper wires across terminal at switch. If burner lights, replace defective switch.
 - ◆ If switch checks ok, place jumper wires across switch wires on gas valve. If burner lights, wires are faulty or connections are bad.

FREQUENT PILOT OUTAGES

- A. Pilot shield not installed.
- B. Pilot flame too high or too low, causing pilot safety to drop out.
 - ◆ Clean and adjust flame for maximum flame impingement on thermopile.

BURNER WON'T STAY LIT

- A. Thermopile wires loose at valve terminals.
 - ◆ Tighten if necessary.
- B. Thermopile wires ground out due to pinched wires.
 - ◆ Free pinched wires if necessary.
- C. Refractory panel placement (if installed).
 - ◆ Refractory panels must be tight against firebox walls. It may be necessary to secure panels with high-temp sealant, especially around intake duct.

MORE TROUBLESHOOTING ON FOLLOWING PAGE

TROUBLESHOOTING

PILOT AND BURNER EXTINGUISH WHILE IN OPERATION

A. No LP (propane) in tank.

- ◆ Check tank and refill if necessary.

B. Glass frame assembly not installed correctly.

- ◆ Refer to installation manual for proper glass frame assembly installment instructions.

C. Defective thermopile or thermocouple.

- ◆ Check thermopile and thermocouple for proper millivolts.

D. Improper pitch on horizontal vent.

- ◆ 1/4" (6mm) rise per foot is required on horizontal venting.

E. Inner vent pipe leaking exhaust gases back into firebox.

- ◆ Check for leaks. Repair if necessary.

F. Improper vent cap installation.

- ◆ Check for proper vent cap installation. Maximum downward slope of horizontal vent cap is 1/4" (6mm). Adjust if necessary.
- ◆ Check vent cap for blockage. Remove debris if necessary.

G. Excessive draft.

GLASS SOOTING

A. Improper log placement.

- ◆ Refer to log placement instructions in fireplace installation manual.

B. Improper venturi setting.

- ◆ Venturi may need to be opened slightly to allow more air into gas mix.

C. Improper pitch on horizontal venting.

- ◆ 1/4" (6mm) rise per foot is required on horizontal venting.

FLAME BURNS BLUE AND LIFTS OFF BURNER

A. Improper Venturi setting.

- ◆ Venturi may need to be closed slightly.

B. Improper vent cap installation.

- ◆ Check for proper vent cap installation.

C. Blockage or vent system leaks.

CONVERSION KIT INSTRUCTIONS

#OCK-S33B NAT GAS CONVERSION KIT / #OCK-S52 LP GAS CONVERSION KIT

WARNING

This conversion kit shall be installed by a qualified service agency in accordance with the manufacturers instructions and all applicable codes and requirements of the authority having jurisdiction. If the information in these instructions is not followed exactly, a fire, explosion or productions of carbon monoxide may result, causing property damage, personal injury or loss of life. The qualified service agency is responsible for proper installation of this kit. The installation is not proper and complete until operation of the converted appliance is checked as specified in the manufacturer's instructions supplied with the kit. Refer to appliance owner's manual or product data plate for proper inlet and manifold pressure adjustments and orifice sizing.

IMPORTANT

THE CONVERSION SHALL BE CARRIED OUT BY A MANUFACTURER'S AUTHORIZED REPRESENTATIVE, IN ACCORDANCE WITH THE REQUIREMENTS OF THE MANUFACTURER, PROVINCIAL OR TERRRITORIAL AUTHORITIES HAVING JURISDICTION AND IN ACCORDANCE WITH THE REQUIREMENTS OF THE CAN/CGA-B149.1 OR CAN/CGA-B149.2 INSTALLATION CODES.

Kit includes: (1) Burner Orifice: NAT #33 / LP #52 (1) Pilot Orifice: NAT #BL22N / LP #BL14LP (1) Gas Label
(1) Valve and Pilot Assembly Conversion Instructions (1) Gas Conversion Label

CAUTION

THE GAS SUPPLY SHALL BE SHUT OFF PRIOR TO DISCONNECTING THE ELECTRICAL POWER, BEFORE PROCEEDING WITH THE CONVERSION.

WARNING

SHUT OFF GAS SUPPLY AND ELECTRIC POWER TO FIREPLACE.
SHUT OFF GAS SUPPLY BEFORE DISCONNECTING ELECTRIC POWER.

IMPORTANT

For high altitude installations: Above 2000ft. (610m) US / 4500ft. (1372m) Canada, consult the local gas distributor or authority having jurisdiction for proper de-rating methods.

PREPARE THE FIREPLACE:

1. Turn fireplace off by pushing in and turning gas control knob clockwise to OFF position.
2. Remove glass frame assembly, logs, log plates and burner assembly from fireplace.

REPLACE BURNER ORIFICES:

Remove existing orifice cap. Install orifice cap included with kit. Tighten cap securely. (Number stamped on burner orifice).

NAT #33

LP #52

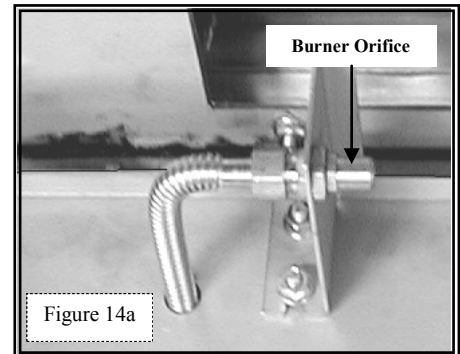

Figure 14a

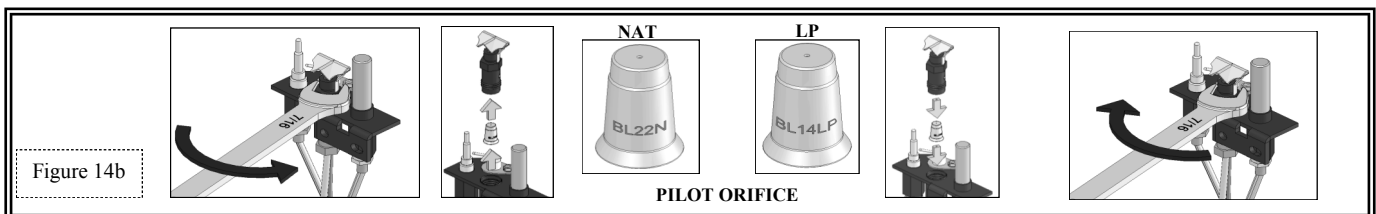

Figure 14b

PILOT ORIFICE

CONVERT PILOT ASSEMBLY:

1. Using a 7/16" wrench, loosen and remove pilot hood by turning counter-clockwise.
2. Remove pilot orifice located inside pilot housing. Install pilot orifice included with kit. NAT #BL22N / LP #BL14LP (Number stamped on pilot orifice).
3. Re-attach pilot hood. Tighten with wrench, making sure hood is centered between thermopile and thermocouple.

CONVERT HI/LO REGULATOR ON GAS VALVE:

Follow instructions included with kit to convert gas valve.

CONVERSION KIT INSTRUCTIONS

COMPLETE THE CONVERSION:

- Adjust burner tube venturi to correct setting by loosening screws adjusting cap and retightening screw.
CORRECT SETTINGS: NAT: 3/16" (5mm) open / L.P: 5/8" (16mm) open
- Re-install burner into fireplace, making sure orifice is properly seated inside burner venturi and pilot hood is above burner assembly.
- Re-install pilot shield.
- Re-install log plates and logs.
- Turn on gas and electrical supplies. Check for leaks at all connections with soapy water, whether field or factory made.
- Test inlet pressure. Visually check pilot flame. Flame should envelope top of flame sensor and extend onto burner far enough for proper ignition. To Adjust pilot: Turn pilot adjustment screw clockwise to decrease or counter-clockwise to increase pilot flame.
- Turn fireplace off.
- Affix gas type sticker to label.
- Re-install glass frame.
- Verify proper ignition and operation of fireplace.
- Complete and affix 'Gas Conversion' label as close to gas valve as possible.

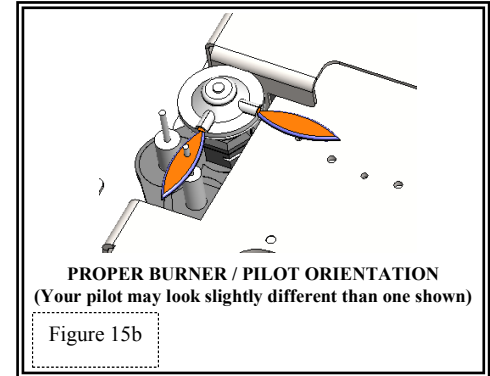
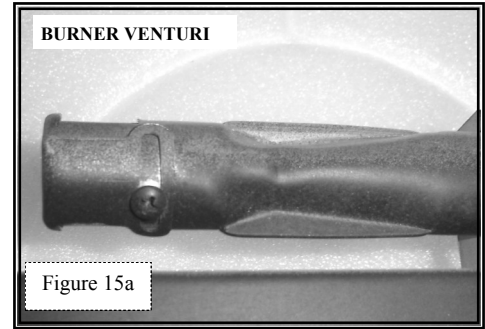

Fireplace Model No.: _____
 This appliance and control was converted on _____ to _____ gas with Kit No.: _____ by _____
 Company: _____
 Address: _____
 Which accepts responsibility that this conversion has been properly made.
 Minimum / Maximum inlet pressures: Refer to rating plate
 Manifold Pressure: Refer to rating plate.
 Orifice size: _____ Input Rating: _____ BTU
 Complete and affix as close as possible to rating plate.

GAS CONVERSION LABEL
(included with conversion kit)

Figure 15c

	<u>NATURAL GAS</u>	<u>LP GAS</u>
MINIMUM INLET GAS PRESSURE	5" WC (1.25 kPa) (7" WC (1.74 kPa) recommended)	11" WC (2.74 kPa) (recommended)
MAXIMUM INLET GAS PRESSURE	10.5" WC (2.62 kPa)	13" WC (3.24 kPa)
MANIFOLD PRESSURE (HI)	3.8" W.C (.95 kPa)	10" WC (2.49 kPa)
MANIFOLD PRESSURE (LO)	1.1" W.C. (.27 kPa)	6.4" WC (1.59 kPa)

CONVERSION KIT INSTRUCTIONS

FLAME APPEARANCE:

Flame appearance is affected by several factors including altitude, venting configuration and fuel quality. Although the venturi setting has been factory set, adjustments may be necessary for optimal performance and visual aesthetics.

When fireplace is first lit, the flames will be blue. Flames will gradually turn yellowish-orange during first 15 minutes of operation. If flames remain blue, or become dark orange with evidence of sooting (black tips), the burner tube venturi may need adjustment.

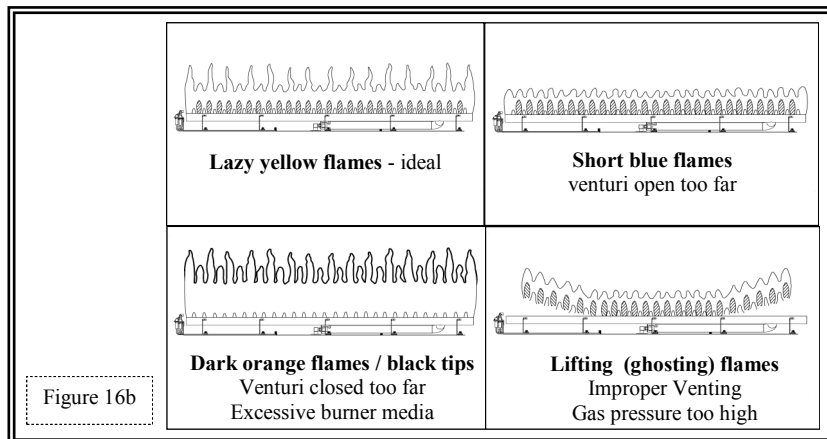
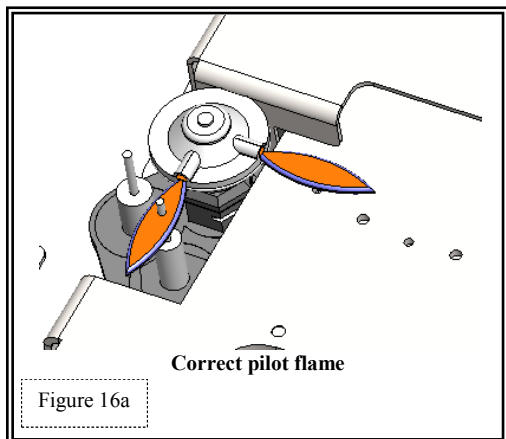

WARNING

Burner tube adjustable venturi positioning should only be performed by a qualified professional service technician.

FACTORY SET BURNER TUBE VENTURI SETTINGS (ADJUST AS NECESSARY FOR YOUR INSTALLATION)

NATURAL GAS	LP (PROPANE) GAS
3/16" (5mm) OPEN	5/8" (16mm) OPEN

BURNER TUBE VENTURI ADJUSTMENT GUIDELINES

VENTURI POSITION	FLAME COLOR	VENTURI ADJUSTMENT
Closed too far	Dark orange flame with black tips	Open venturi setting slightly
Open too far	Blue flames	Close venturi setting slightly

IMPORTANT

SLIGHT ADJUSTMENTS TO BURNER VENTURI OPENING CREATE DRAMATIC RESULTS. ADJUST AT SLIGHT INCREMENTS UNTIL DESIRED LOOK IS ACHIEVED. ALWAYS BURN FIREPLACE FOR AT LEAST 15 MINUTES AND ALLOW TIME TO COOL BEFORE MAKING ANY FURTHER ADJUSTMENTS.

TO ADJUST VENTURI:

1. Remove glass frame assembly.
2. Remove log set and log plates.
3. Remove burner assembly.
4. Loosen screw on burner venturi and adjust as necessary. Tighten screws.
5. Reinstall all components previously removed.
6. Light fireplace and wait 15 minutes before determining if any further adjustments are needed.

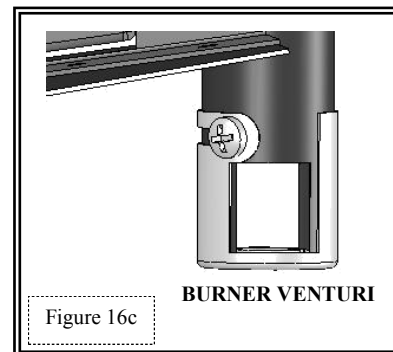

MAINTENANCE

The appliance is required to be inspected at least once a year by a professional service person.

The compartment below firebox must be cleaned at least once a year, more frequent cleaning may be required due to excessive lint from carpeting, bedding materials, or other fibrous materials. Use a vacuum to clean all components at least once a year.

NOTE

INSTALLATION AND REPAIR SHOULD BE DONE ONLY BY QUALIFIED SERVICE PERSON. THE APPLIANCE SHOULD BE INSPECTED BEFORE USE AND ANNUALLY BY A QUALIFIED SERVICE PERSON. MORE FREQUENT CLEANING MAY BE REQUIRED DUE TO EXCESSIVE LINT FROM CARPETING, BEDDING MATERIALS, ETC. IT IS IMPERATIVE THAT CONTROL COMPARTMENTS, BURNERS AND CIRCULATION AIR PASSAGEWAYS OF THE APPLIANCE BE KEPT CLEAN.

CONTROL BOARD SYSTEM

- Annual cleaning of burner system is required. Vacuum all components thoroughly.
- Visually check for blocked port holes, especially near the pilot. Blocked port holes may cause delayed ignition.
- Visually check pilot light and burner when in operation. Flames should be steady, not lifting or floating.

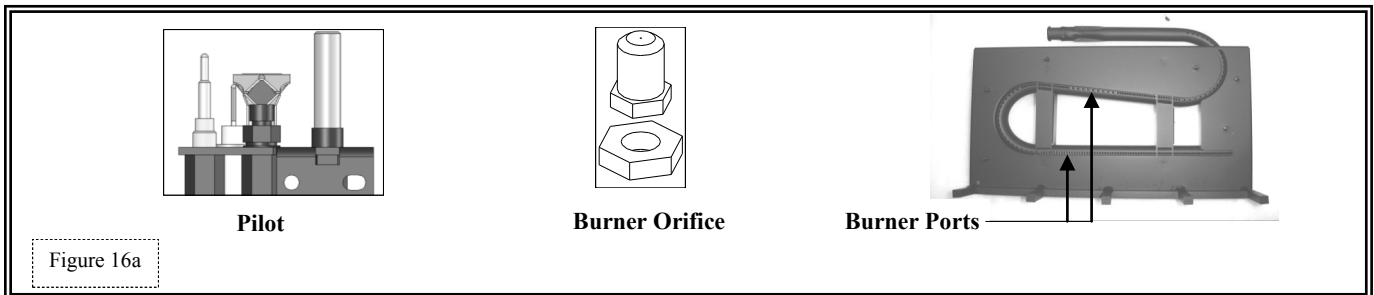

FAN

The fan should be disconnected from electrical current, and cleaned (vacuumed) every six months. The bearings are sealed and require no oiling.

VENT SYSTEM

Annual examination of venting system by a qualified agency is required.

IF VENT-AIR INTAKE SYSTEM IS DISASSEMBLED FOR ANY REASON, RE-INSTALL PER INSTRUCTIONS PROVIDED WITH INITIAL INSTALLATION.

The flow of combustion and ventilation air must not be obstructed.

GLASS CLEANING & REPLACEMENT

- Clean glass only when cool and only with non-abrasive cleansers.
WARNING: DO NOT OPERATE APPLIANCE WITH GLASS/FRAME ASSEMBLY REMOVED, CRACKED OR BROKEN. REPLACEMENT OF THE GLASS SHOULD ONLY BE PERFORMED BY A LICENSED OR QUALIFIED SERVICE PERSON.
- Use protective gloves to handle any broken or damaged glass assembly components.
- The glass assembly, part #700-015T, shall only be replaced as a complete unit, as supplied by Hussong Mfg. Co., Inc.
- Replacement of glass assembly, part #700-015T, must only be performed by a licensed or qualified service person.
DO NOT SUBSTITUTE MATERIALS.
- Do not strike or slam glass door assembly.

IMPORTANT

ANY SAFETY SCREEN OR GUARD REMOVED FOR SERVICING MUST BE REPLACED PRIOR TO OPERATING THE APPLIANCE.

CAUTION

LABEL ALL WIRES PRIOR TO DISCONNECTION WHEN SERVICING CONTROLS. WIRING ERRORS CAN CAUSE IMPROPER AND DANGEROUS OPERATION. VERIFY PROPER OPERATION AFTER SERVICING.

KEEP APPLIANCE AREA CLEAR OF COMBUSTIBLE MATERIALS, SUCH AS GASOLINE AND OTHER FLAMMABLE VAPORS AND LIQUIDS.

REPLACEMENT PARTS LIST

Replacement parts are available through your local dealer. Contact them for availability and pricing.

MILLIVOLT BOARD AND PARTS

LKF-770	Lakefield Millivolt Board - Nat Gas	700-095	Pilot Orifice - LP Gas
LKF-771	Lakefield Millivolt Board - LP Gas	700-203	Manual Shut-off Valve
700-023	On/Off Rocker Switch	700-213B	18" Flexible Gas Line-Black
700-086N	S.I.T. Valve - Natural Gas	700-226	Flexible Gas Line-Valve to Burner Connection
700-087	S.I.T. Valve - LP Gas	700-233	Natural Gas Burner Orifice #33
700-064	Pilot / Generator / Thermocouple - Nat Gas	700-252	LP Gas Burner Orifice #52
700-064-1	Pilot / Generator / Thermocouple - LP Gas	OCK-S33B	Natural Gas Conversion Kit
700-090	Piezo Igniter w/ Nut (no wire)	OCK-S52	LP Gas Conversion Kit
700-099	Flexible Pilot Tubing (Valve to Pilot)	S36-043B	Pilot Shield
700-092	Millivolt Generator	BRK-35	Burner Tube
700-093	Thermocouple	BRK-135	Burner Plate
700-094	Pilot Orifice - Natural Gas		

GLASS & GLASS GASKET

700-015T	Standard Glass with Gasket
900-006	1-1/8" Glass Gasket w/ Adhesive

LOG SET

BRK-500	Log Set
B1	#1 Log
B2	#2 Log
B3	#3 Log
B4	#4 Log
B5	#5 Log
B6	#6 Log
B7	#7 Log
900-REMB	Rock Wool Embers

Hussong Manufacturing Co., Inc.
P.O. Box 577
204 Industrial Park Drive
Lakefield, MN 56150-0577
USA

Lakefield #56150

www.kozyheat.com